

PACKAGING & DIELINES

THE DESIGNER'S BOOK OF PACKAGING DIELINES

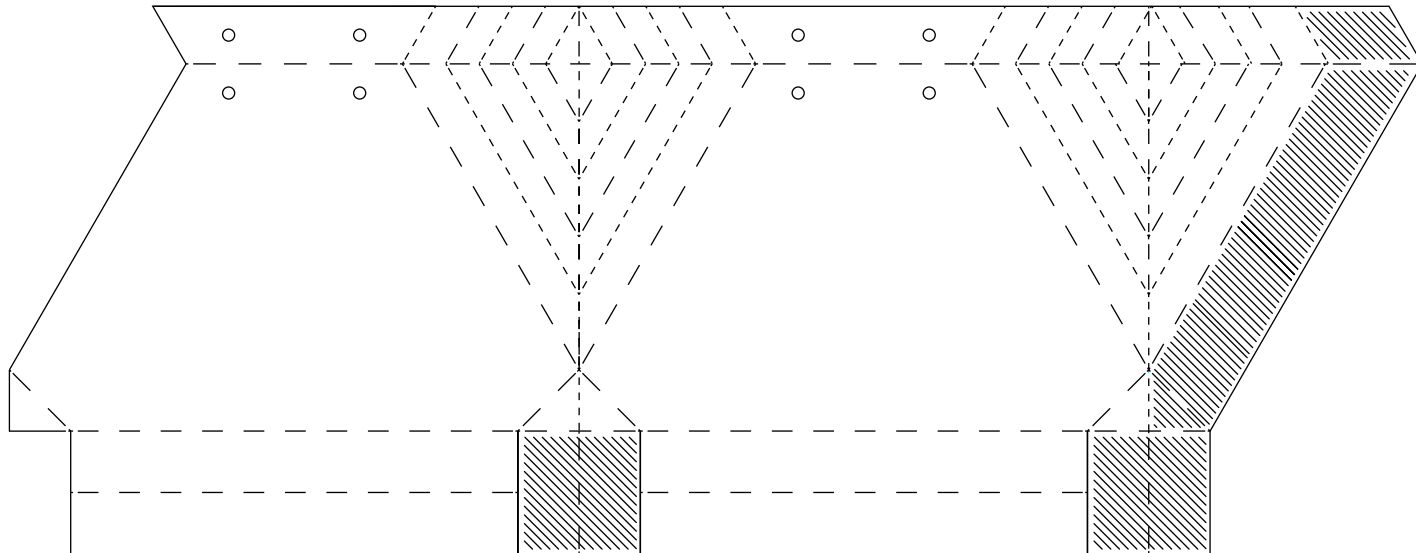



BROUGHT TO YOU BY THE AWARD-WINNING CREATIVE TEAM @DESIGNPACKAGING

CONTENTS

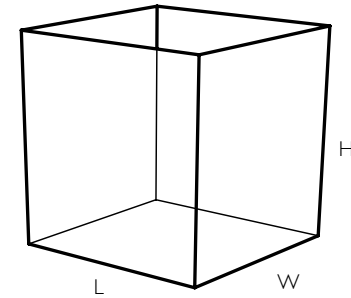
SHOPPING BAGS	4
RIGID BOXES	20
FOLDING BOXES	46
GIFT CARD CARRIERS	104

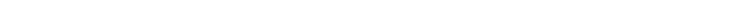
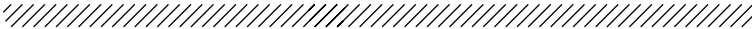
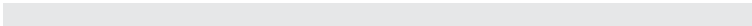

LEGEND

	Trim Line
	Fold Line
	Glue Area
	Self Adhesive Strips
	Grey Board

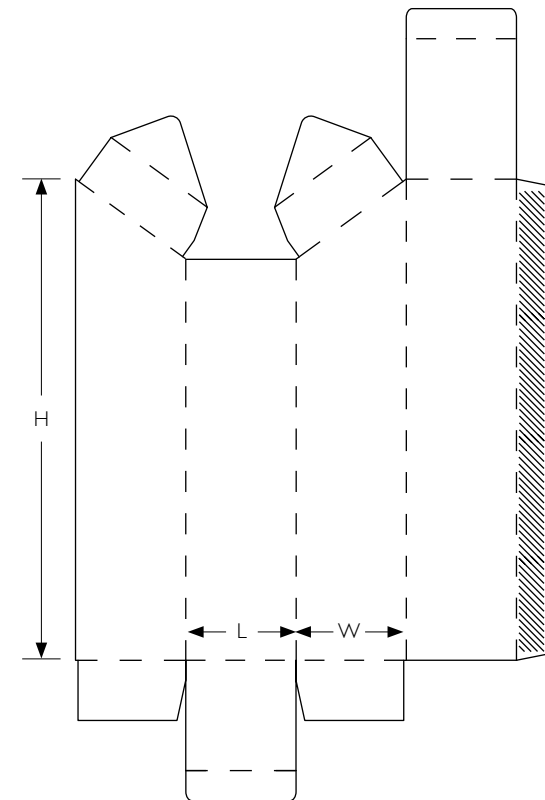

HELLO

The team at Design Packaging whole-heartedly believes in the value of collaboration, and the generosity of idea sharing. The Creative Division @DesignPackaging creates multiple structural comps weekly as part of our evolutionary design process. That process relies on sketching and proto-typing as a means to innovate by testing new folds, new unveiling processes, and new material combinations that meet the specific goals set by every project.

So many of these explorations in design, geometry, and unveiling go unused that we would feel selfish not sharing them with the packaging design community. We have also included dielines for many packaging standards, for some of the more common applications that can serve as a starting point to evolve into more complex structures.

We appreciate the support of Andrew Gibbs and the community created by his team at [TheDieline](#), to them we extend our thanks. We hope you enjoy this book and are able to share the inspiration you find within its pages as well.

Thank you,



Evelio Mattos
Creative Director



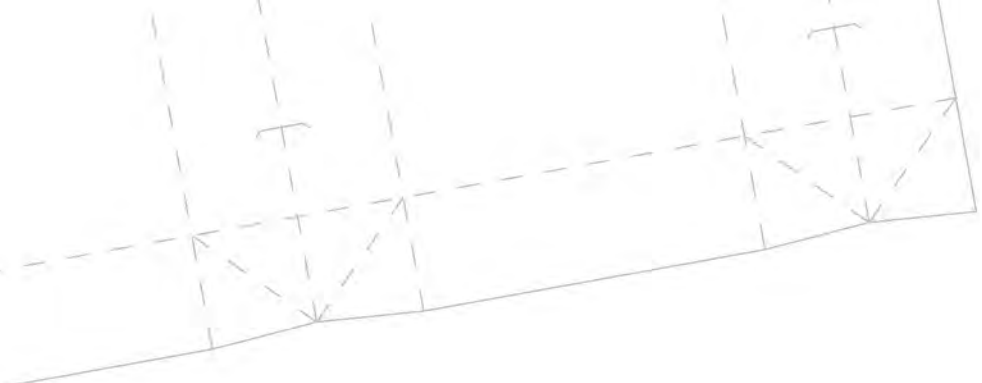

SHOPPING BAGS

The embodiment of a brand, its promises, values, mission can be felt in the tactile qualities of a shopping bag handle, the sound of its paper, and the strength of its structure. Beyond their utilitarian function or service as walking billboards, shopping bags communicate their message in a flash through well designed visual cues. We've provided several shopping bag templates in the pages that follow, each template can be scaled to meet your brand's specific needs. We recommend that you always print out the dielines to confirm dimensions, proportions, user experience, and that the structure is what you envisioned prior to applying artwork.

EURO-STYLE SHOPPING BAG

The Euro-style shopping bag is defined by its reinforced turned edge along the top of the bag. This fold provides added rigidity and differentiates the bag construction by commanding a level of luxury. The turned edge is accented by either using a four knot, or vanishing type handle to elevate the tactile experience.

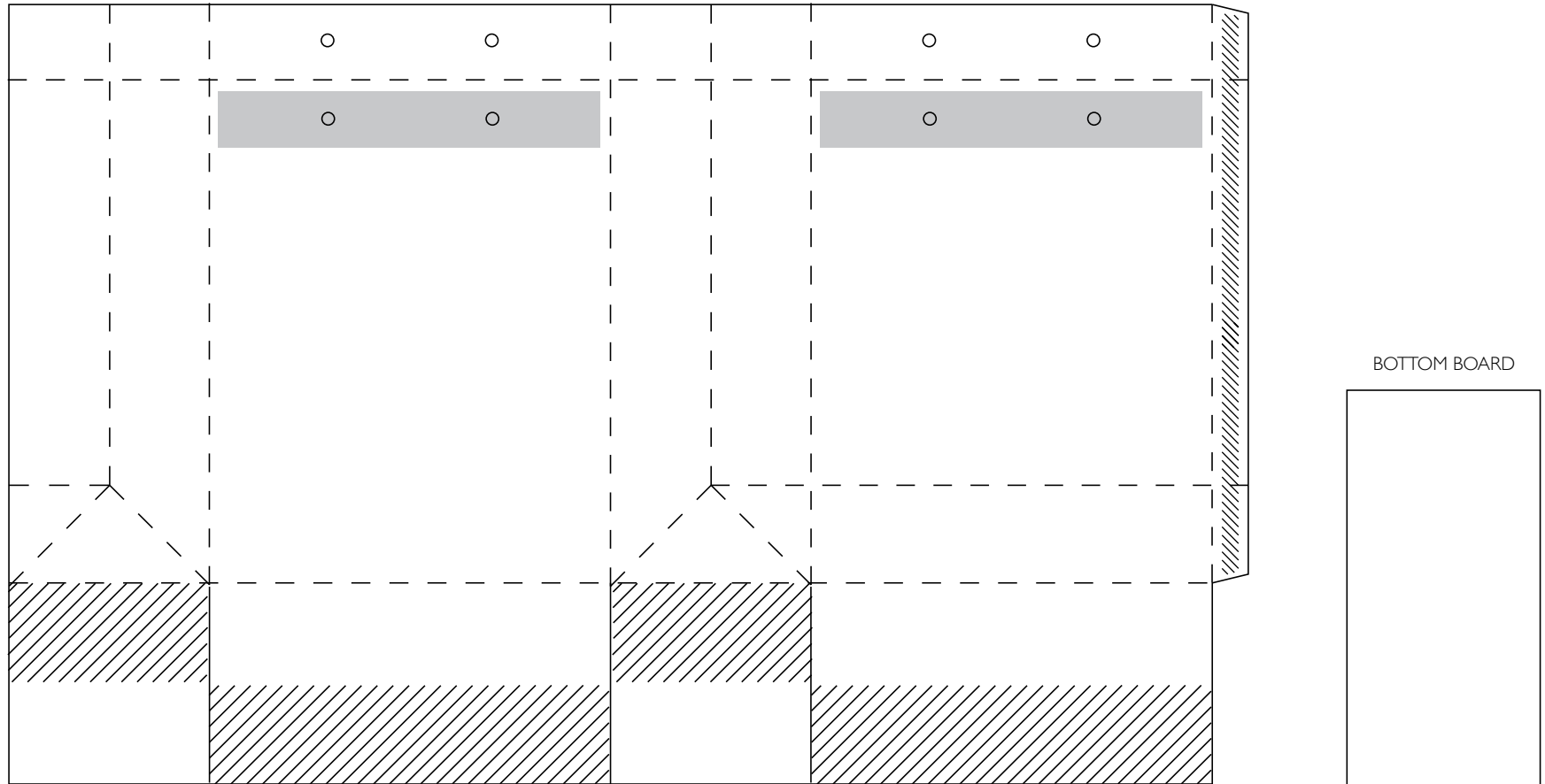



TRIANGLE BAG

The Triangle Shopping Bag is a specialty bag most often found carrying three bottles of a fine wine, with a simple insert construction protecting the bottles. Due to its angled footprint, this bag is best used as a taller structure with a narrower footprint to maintain a level of comfort when carried.

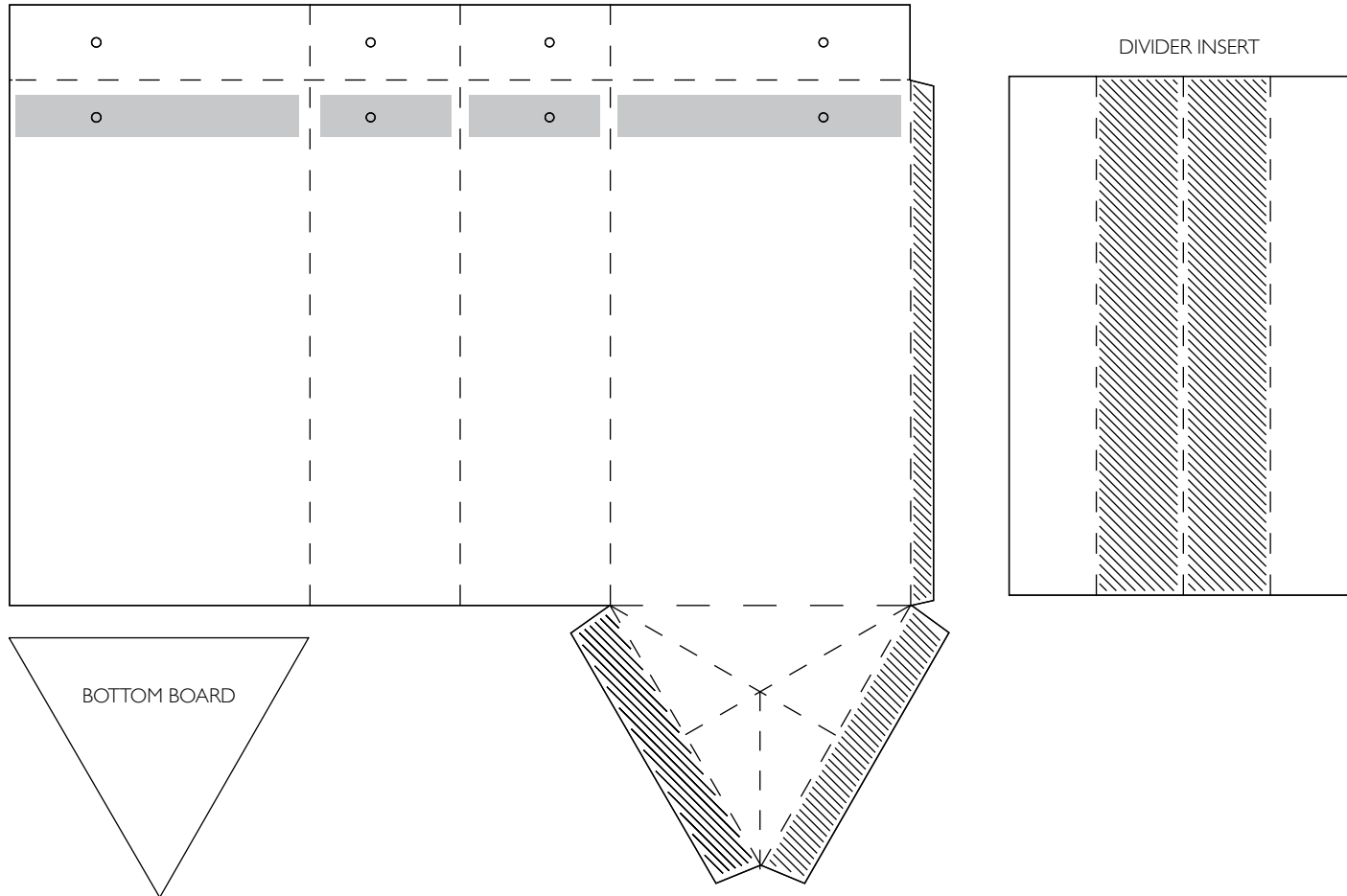



PLEATED SHOPPING BAG

The Pleated Shopping Bag is a specialty retail shopping bag that alludes to the future of retail through facets, folds, and contrast.

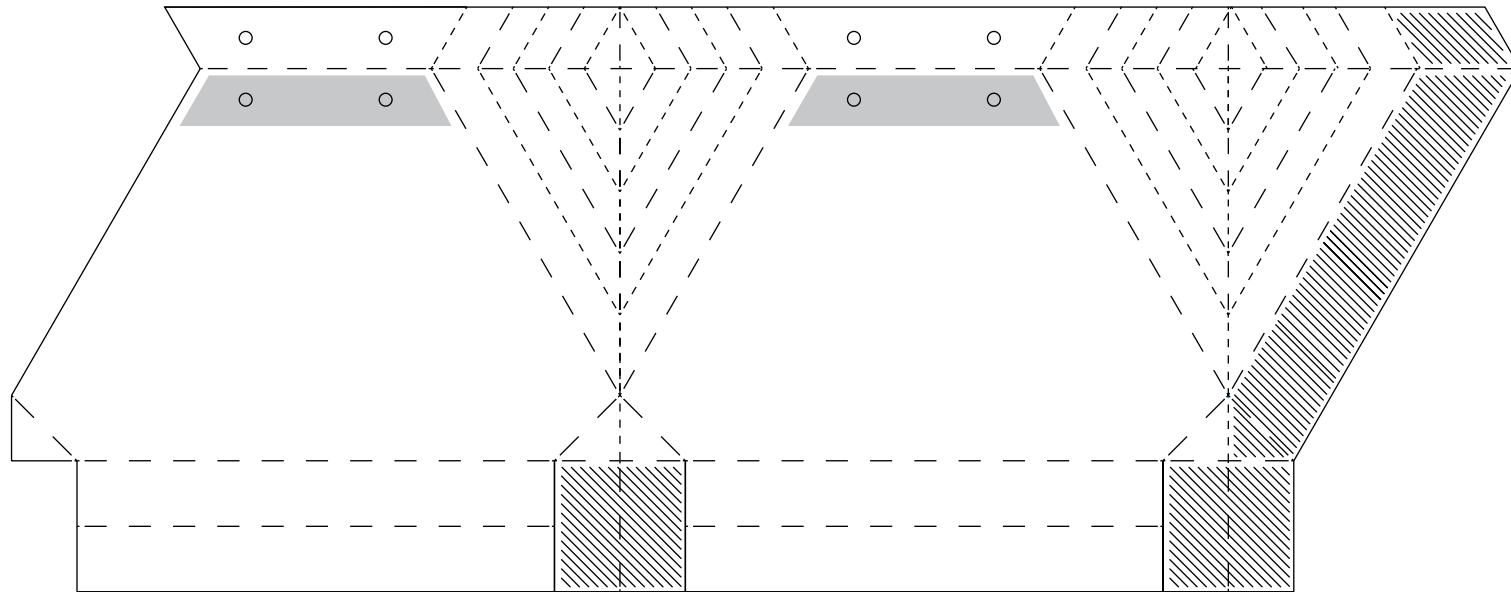

BOTTOM BOARD



VALLEY FOLD



PEAK FOLD



GIFT WRAP BAG

The Gift Wrap Bag is a simple solution that allows fast and easy gift wrap behind the counter or at the cashwrap stand within retailers. By utilizing a heavier board, you may be able to eliminate the need for an internal box completely.

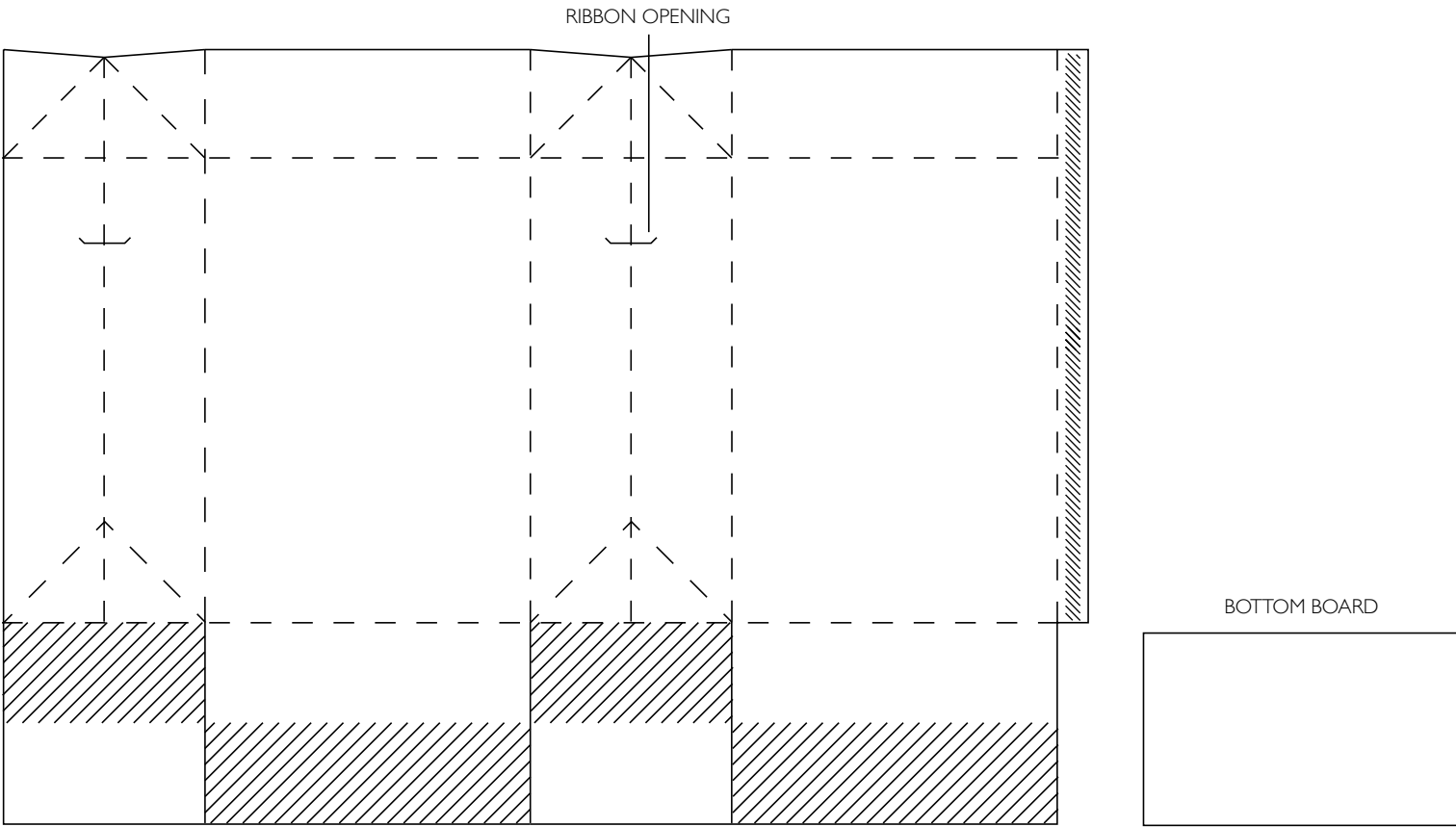



DIECUT HANDLE BAG

The Diecut Handle Bag is a standard shopping bag on the lower end of the pricing spectrum. It's simplicity is derived from the die cut vs. requiring a hand-applied handle. The die-cut handle will require a reinforcement board under the turn top to provide the adequate structure to carry the appropriate weight for the internal volume of the bag.

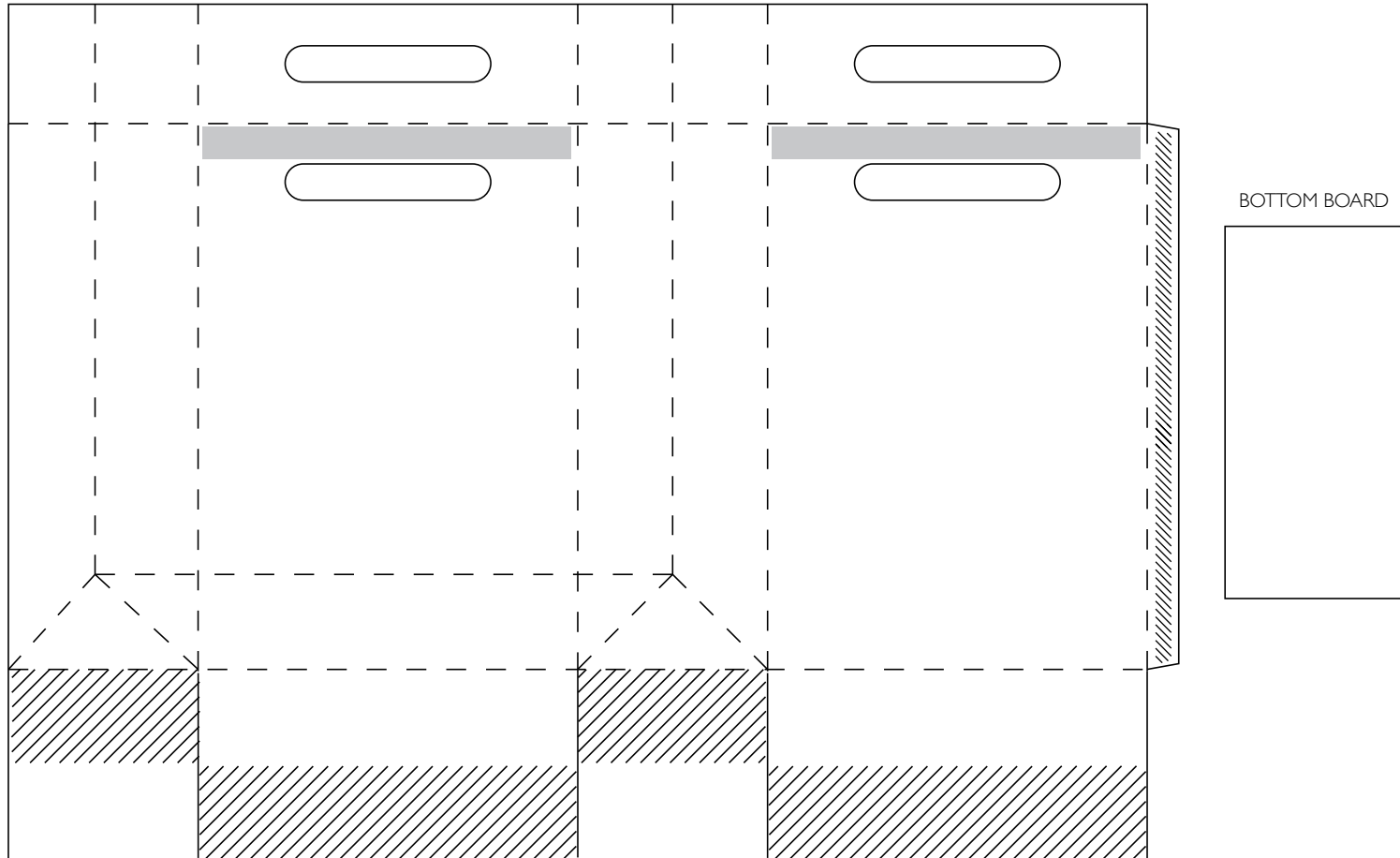



DIECUT HANDLE BAG WITH FLAP

This is an evolution of the die-cut handle bag, elevating the look and feel of the die cut through the use of magnets and flap closures. It's simplicity is derived from the die cut vs. requiring a hand-applied handle. The flap and handle area will need a reinforcement board to provide the structure required to hold the client's specified product weight without tearing.

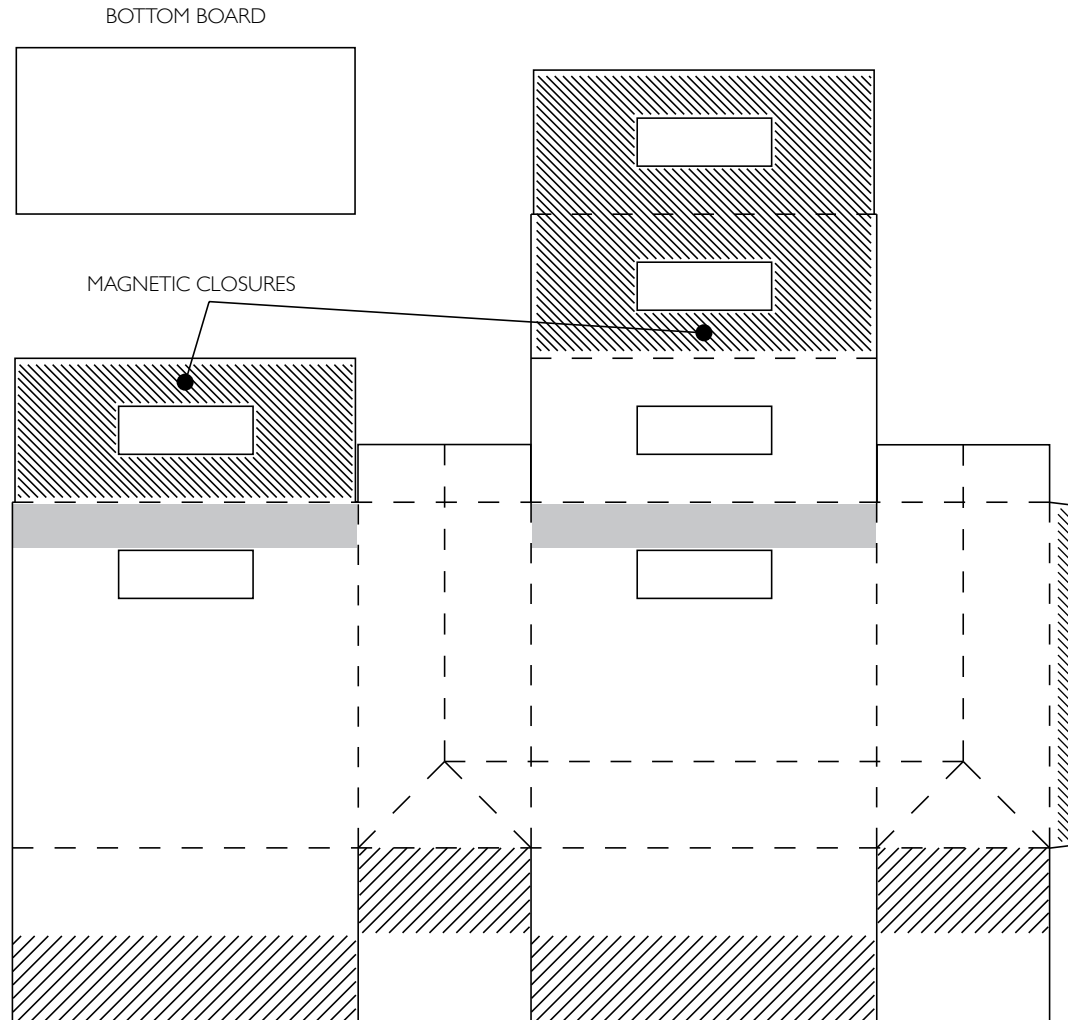

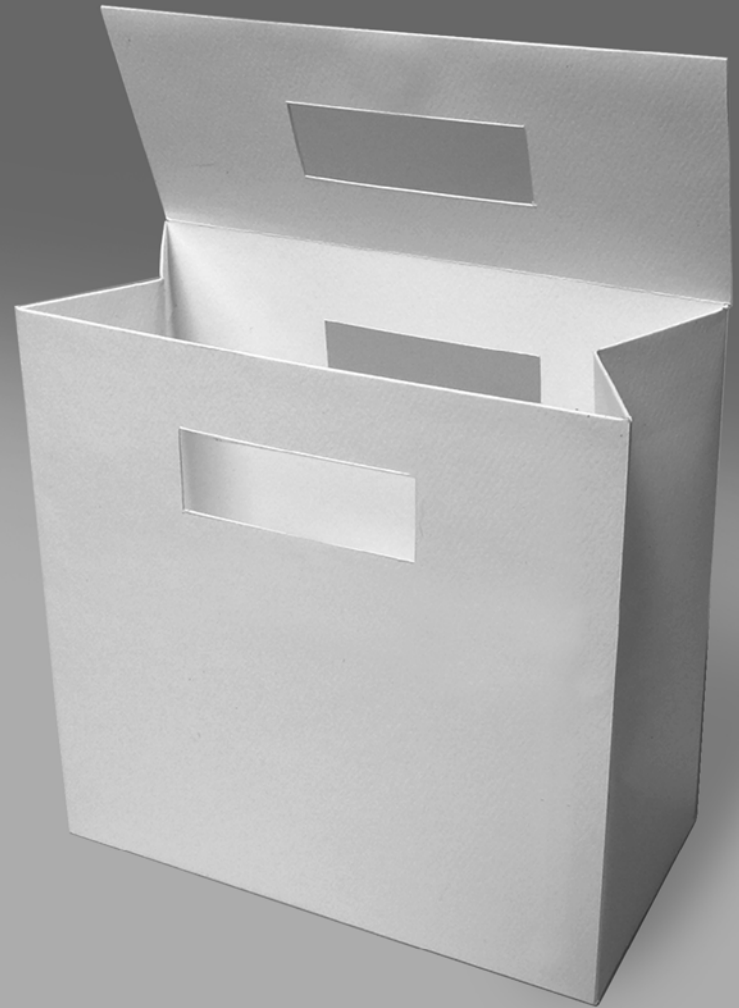
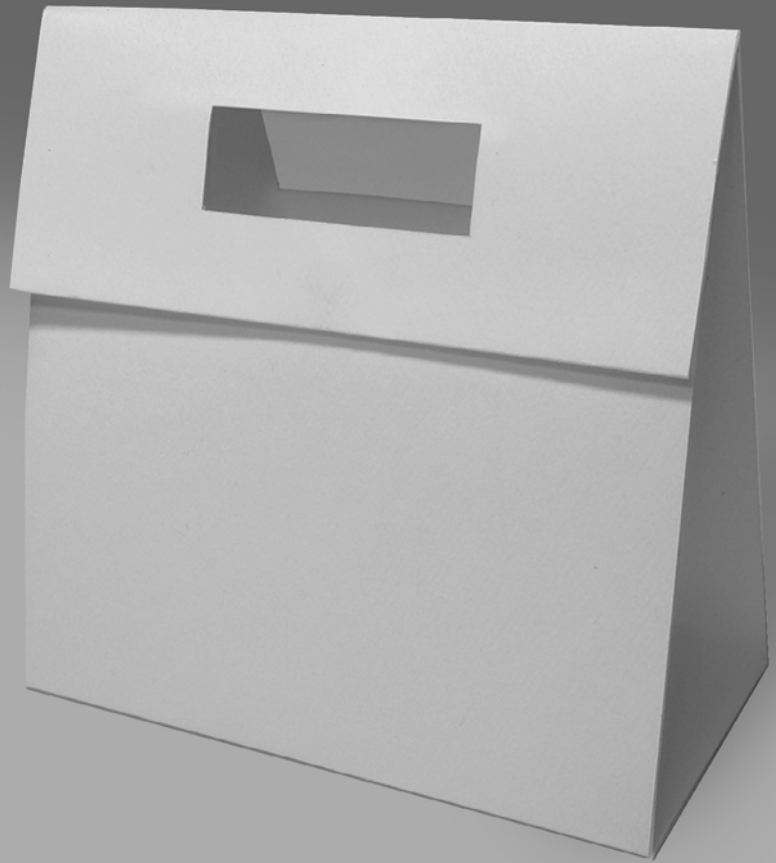

NWPP TOTE BAG

This synthetic non-woven polypropylene shopping bag provides a reusable solution for retailers, which can be produced both in a laminated and unlaminated option. Handles are variable as they can be made of self material, or a new material can be introduced as an accent to the overall design.

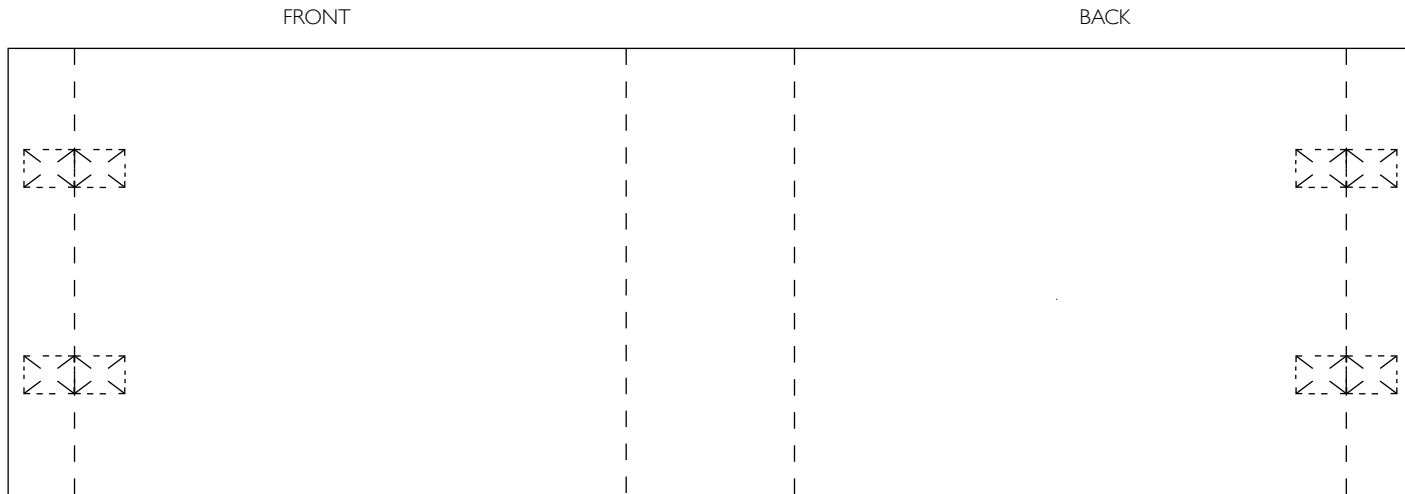



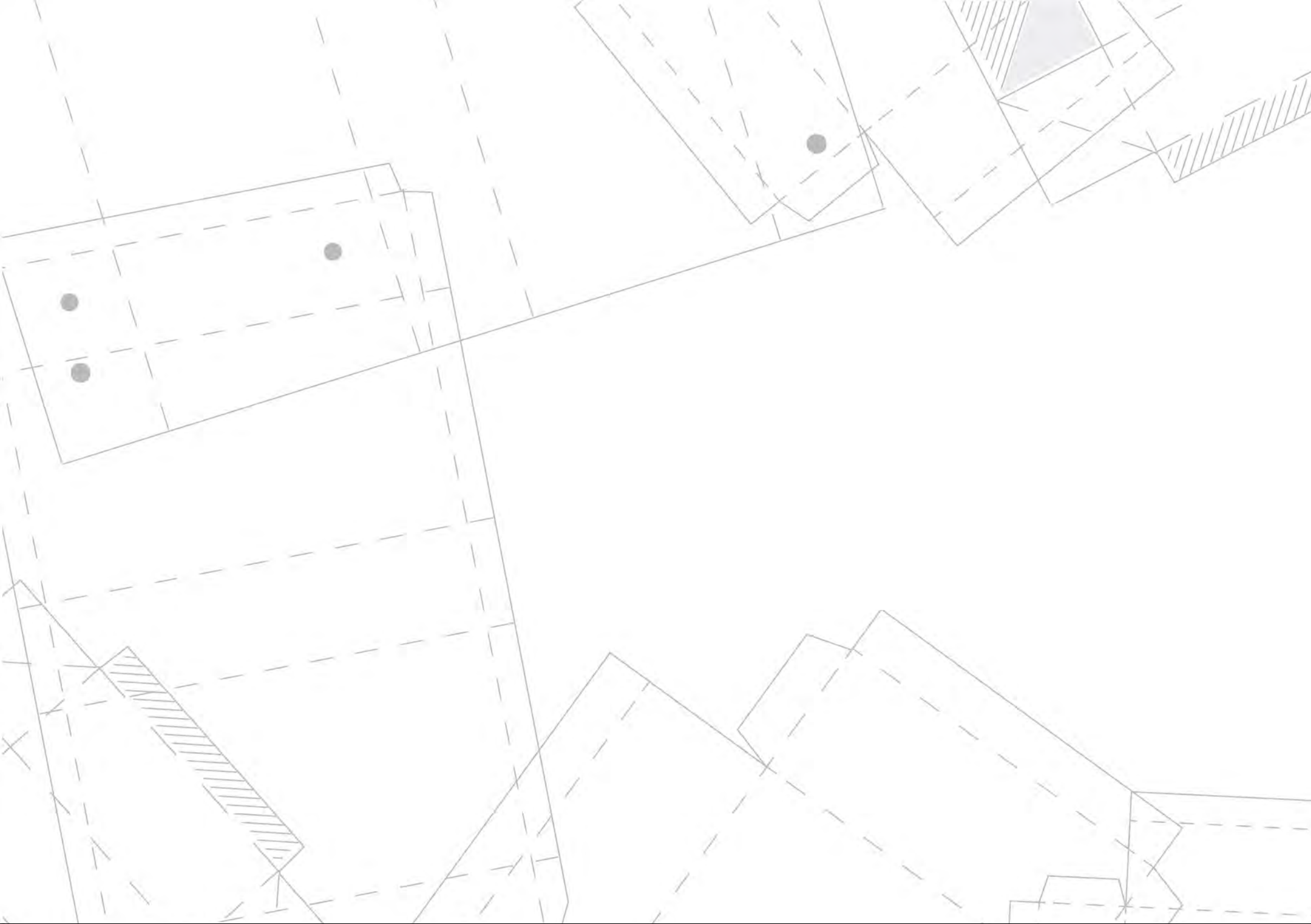



RIGID BOXES

Rigid boxes are often seen in luxury packaging because of the weight, strength, and firmness conveyed by their structure. These dielines for rigid boxes, focus on the paper wrap that is applied to the exterior of the heavy weight chipboard (grey board) that give the boxes their structure. The interior of rigid boxes are often wrapped by a paper liner that carries a consistent look and feel throughout the unveiling experience. We recommend that you always print out the dielines to confirm dimensions, proportions, user experience, and that the structure is what you envisioned prior to applying artwork.

2-PIECE RIGID BOX

The 2-Piece Rigid Box, also known as a rigid set-up box, consists of a base and lid. Lid to base proportions depend on design and personal taste. A deeper lid or full telescoping lid can at times elevate perceived value.

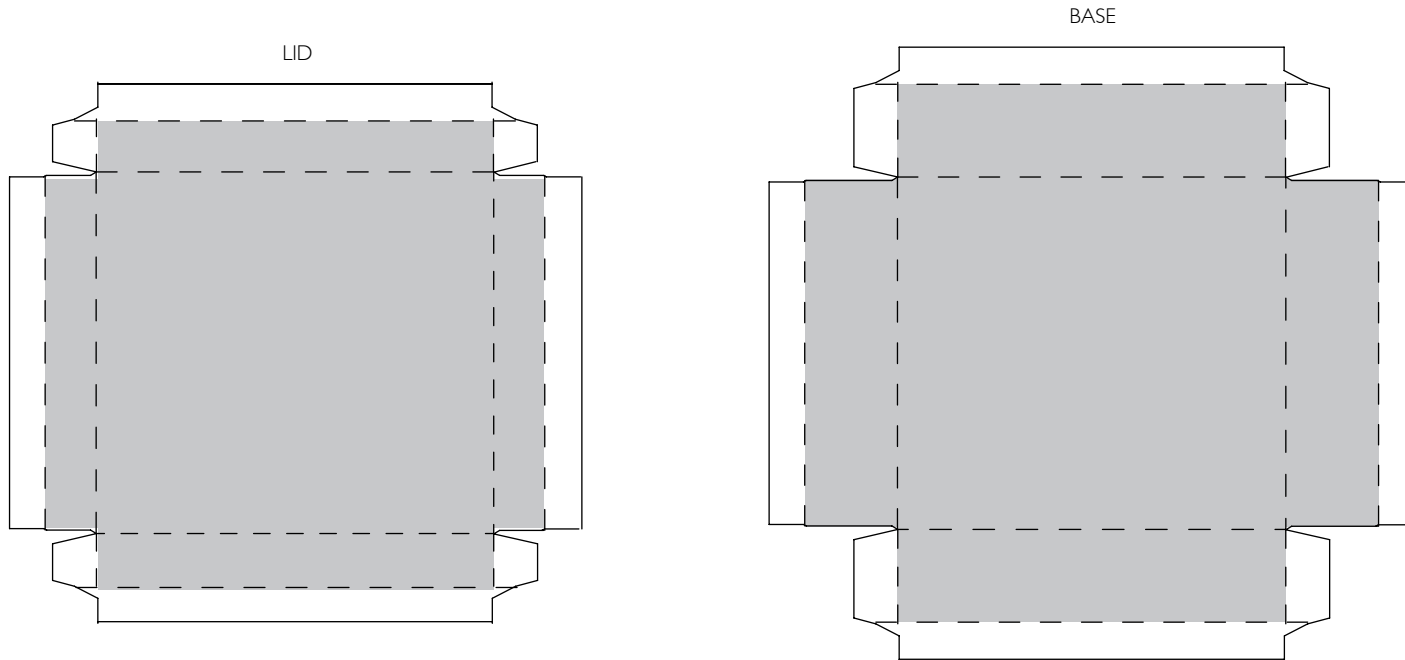

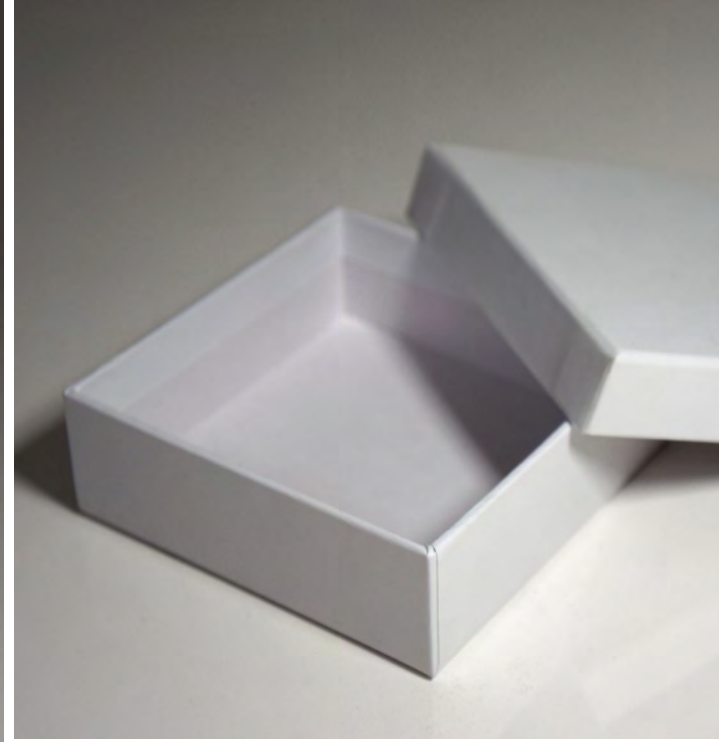

COLLAPSIBLE RIGID TRIANGLE BOX

The Collapsible Rigid Triangle Box creates unique opportunities for application and user experience. It's space-saving collapsibility is created by the left and right folding panels.

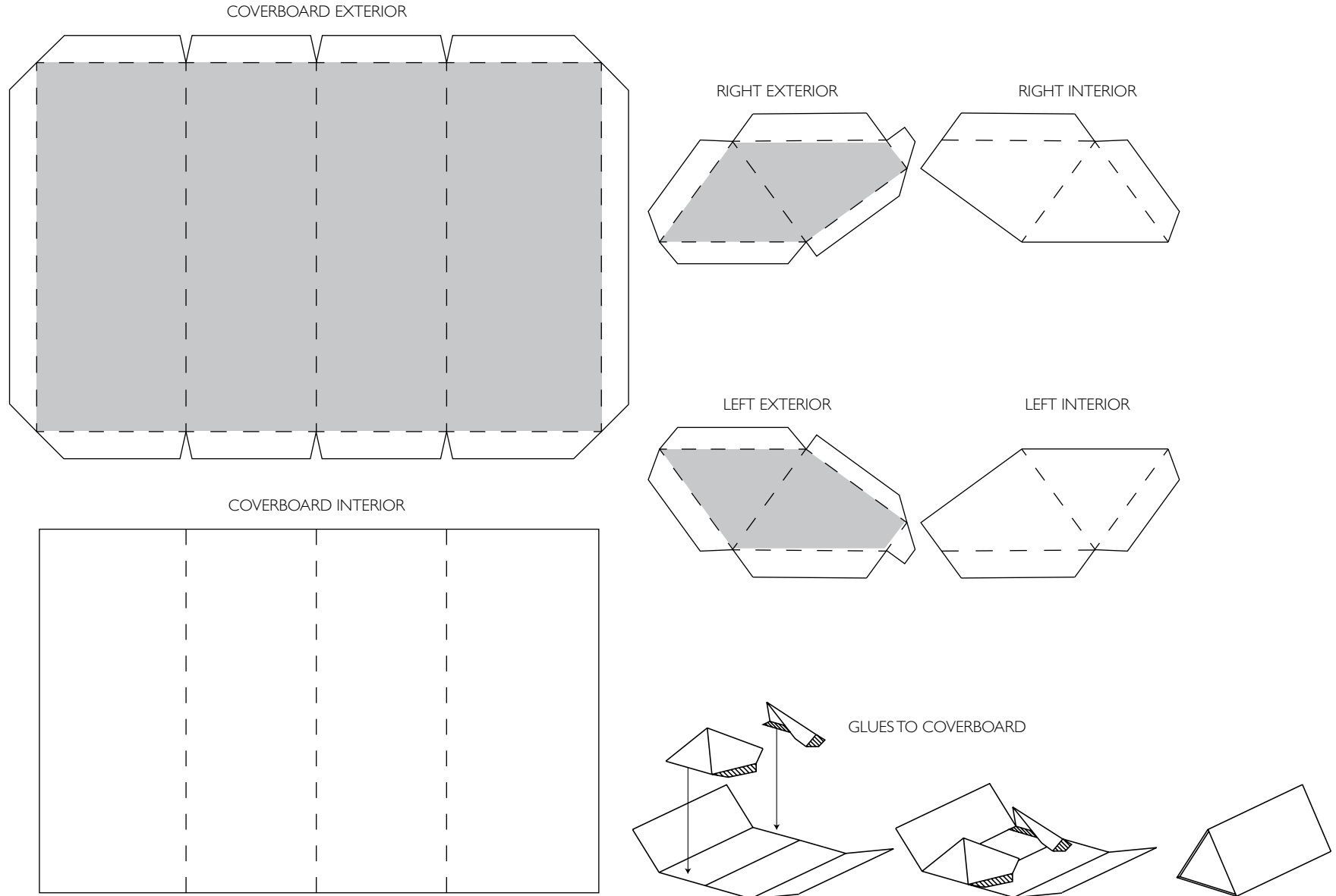

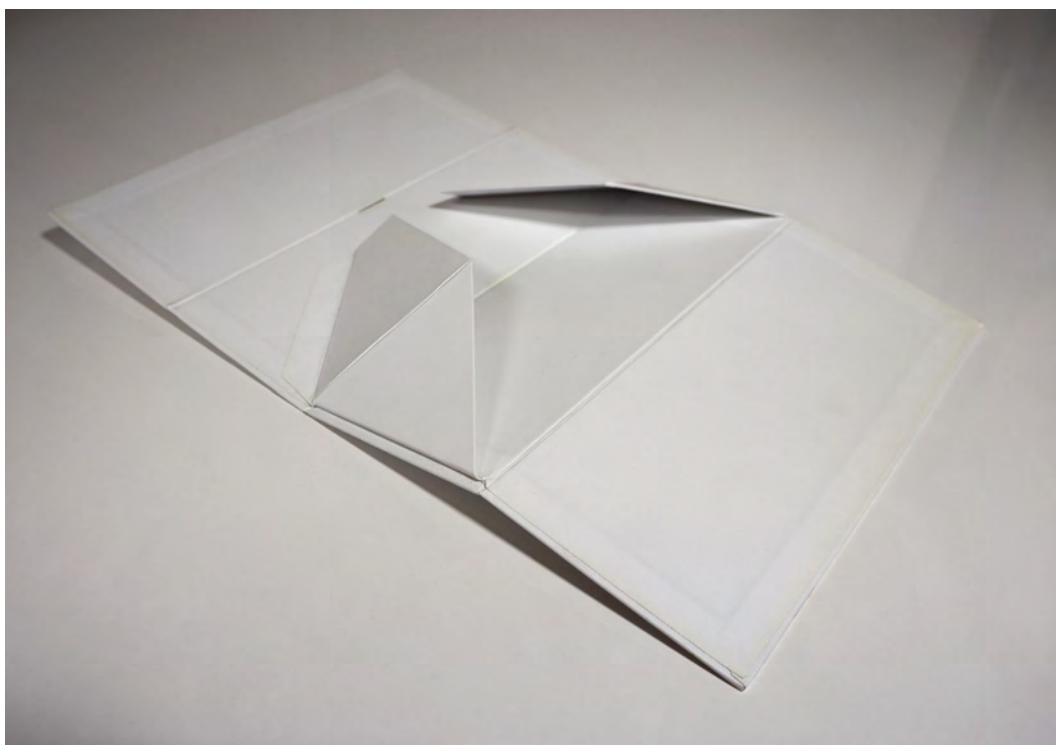
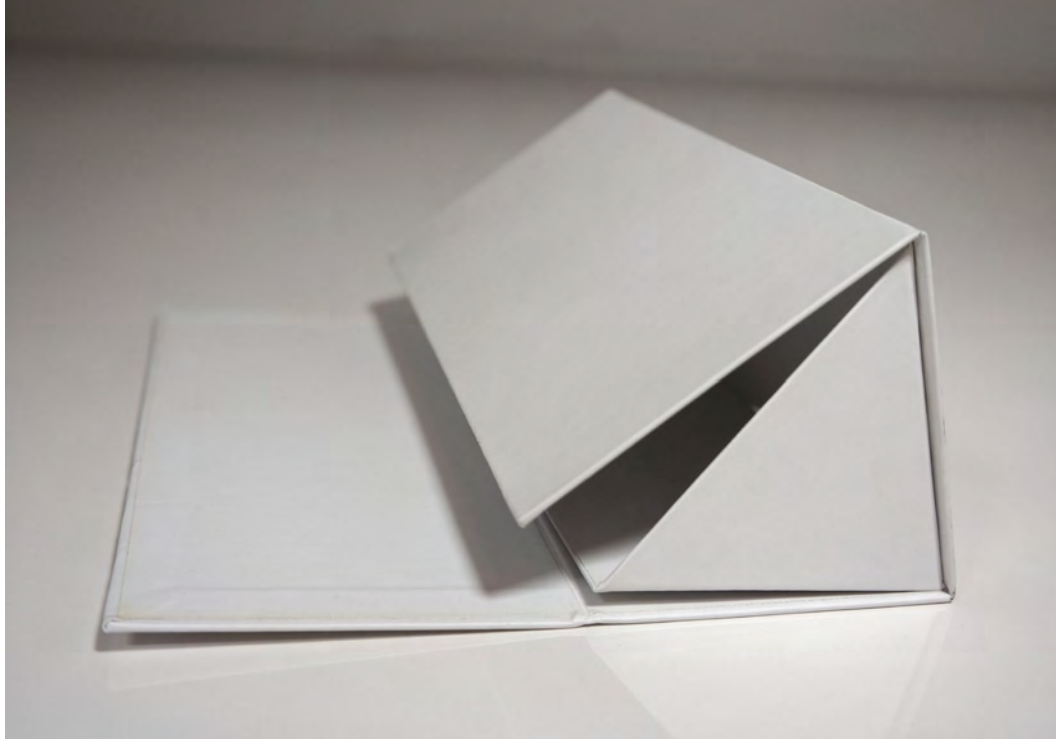
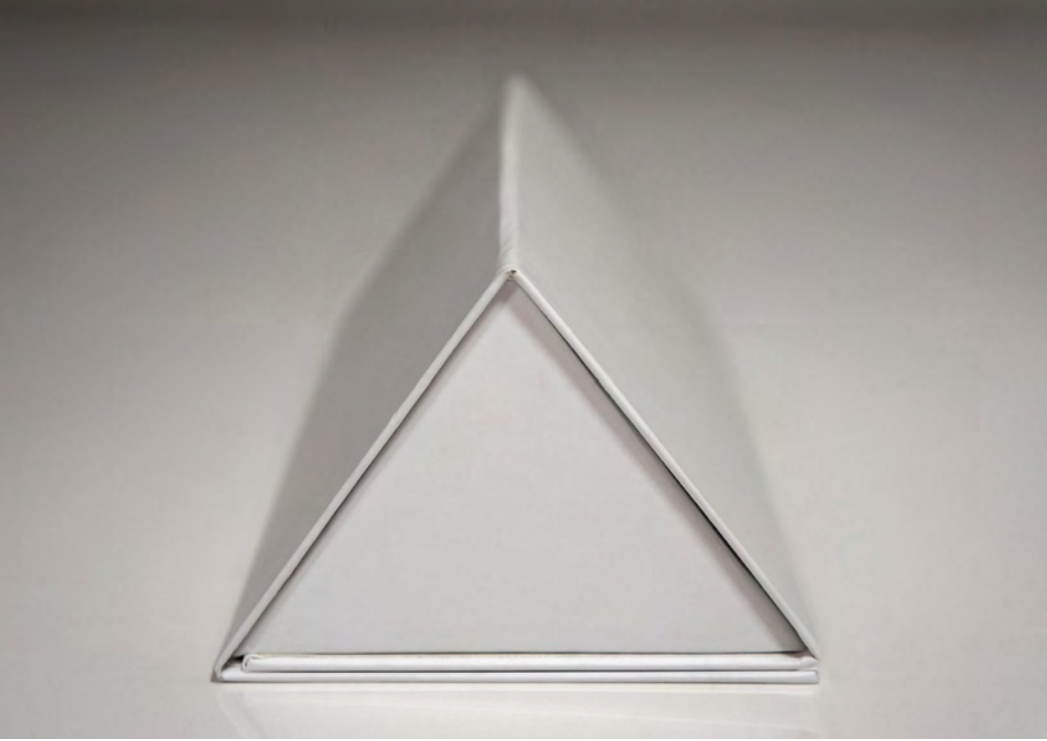

RIGID FLIP TOP BOX

The Rigid Flip Top Box and its segmented two-hinge lid can be closed through several methods: sleeve, ribbon closure or magnets. The lid rests securely in place on the interior wall, while the interior cuff panel provides a stopping point.

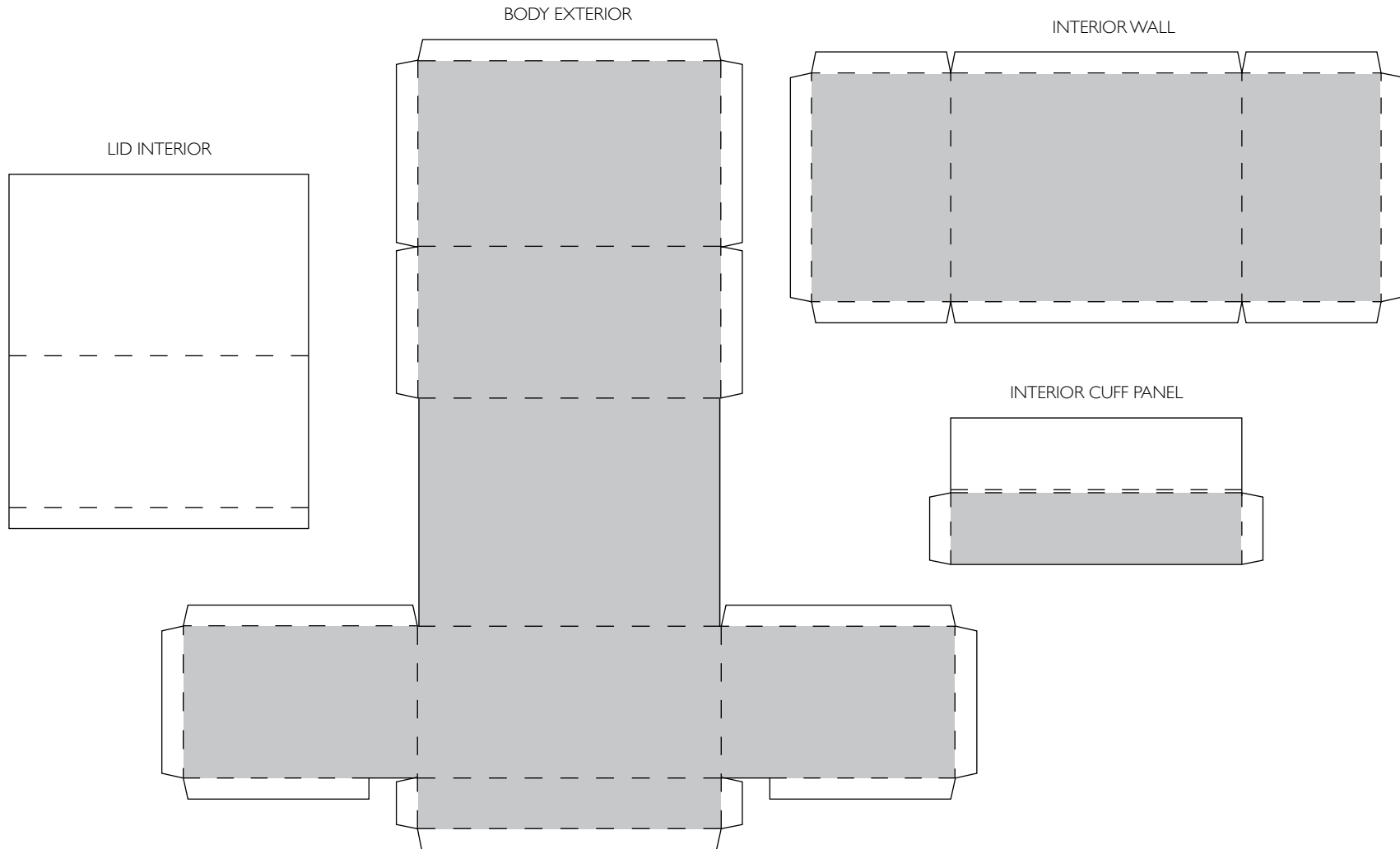



WIDE TRIANGULAR FLIP-TOP BOX

The Wide Triangular Flip-top box, is best used with an insert to hold an individual product. The angled flip top gives the user an alternative to the standard horizontal/vertical haptic motion.

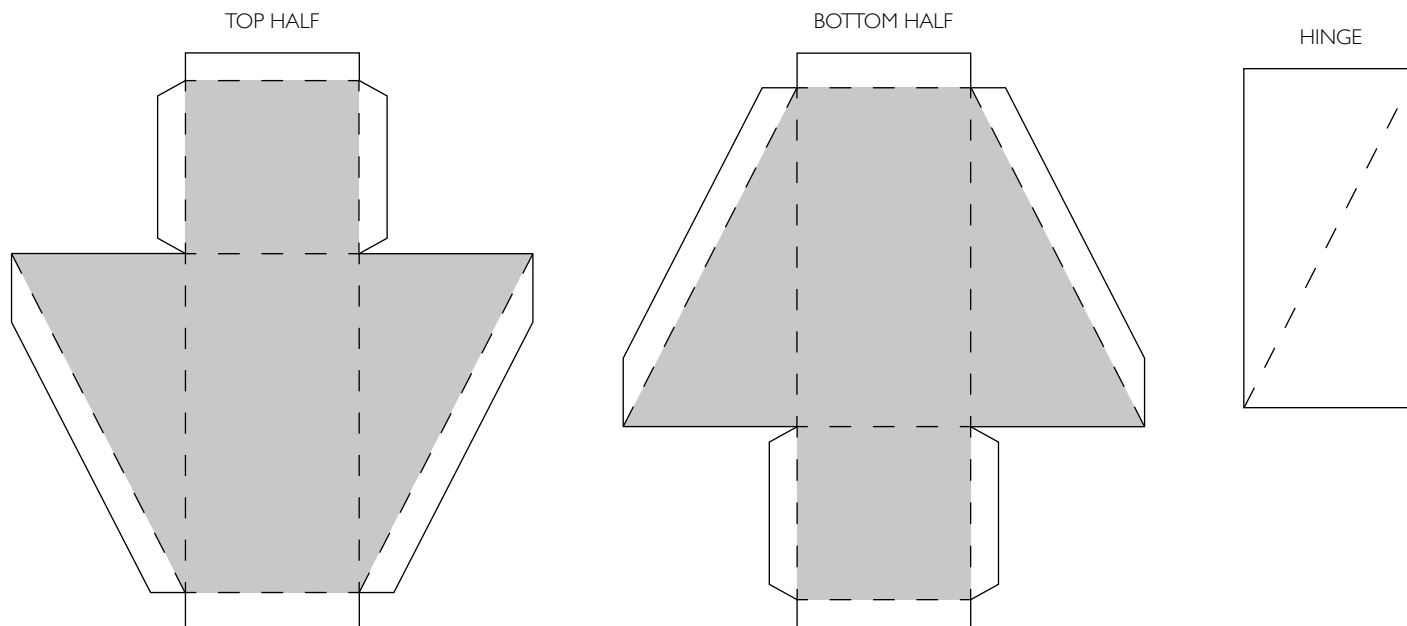

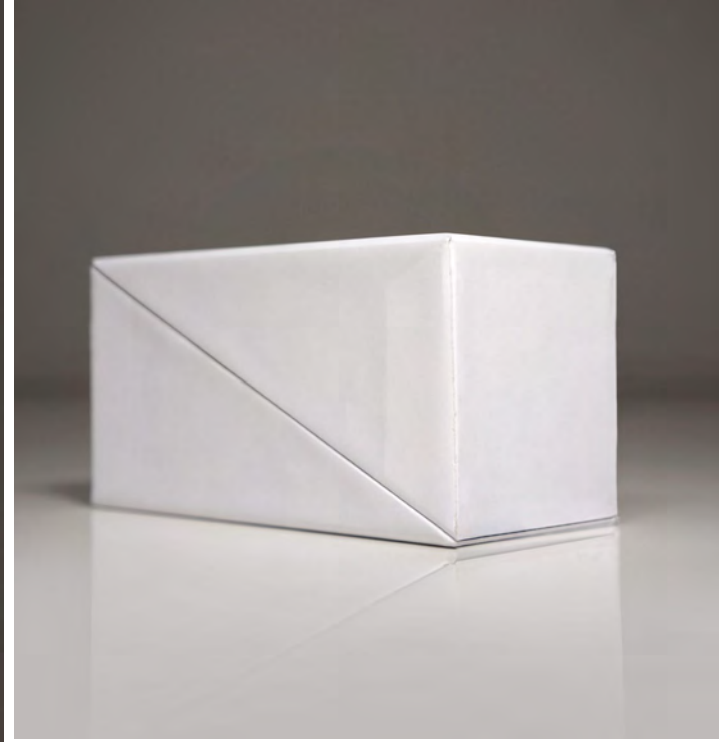

DRAWER BOX

The Drawer Box is made up of two components: a sleeve and a drawer. Being held together through friction, the drawer should pull forward in one smooth motion to reveal the product inside.

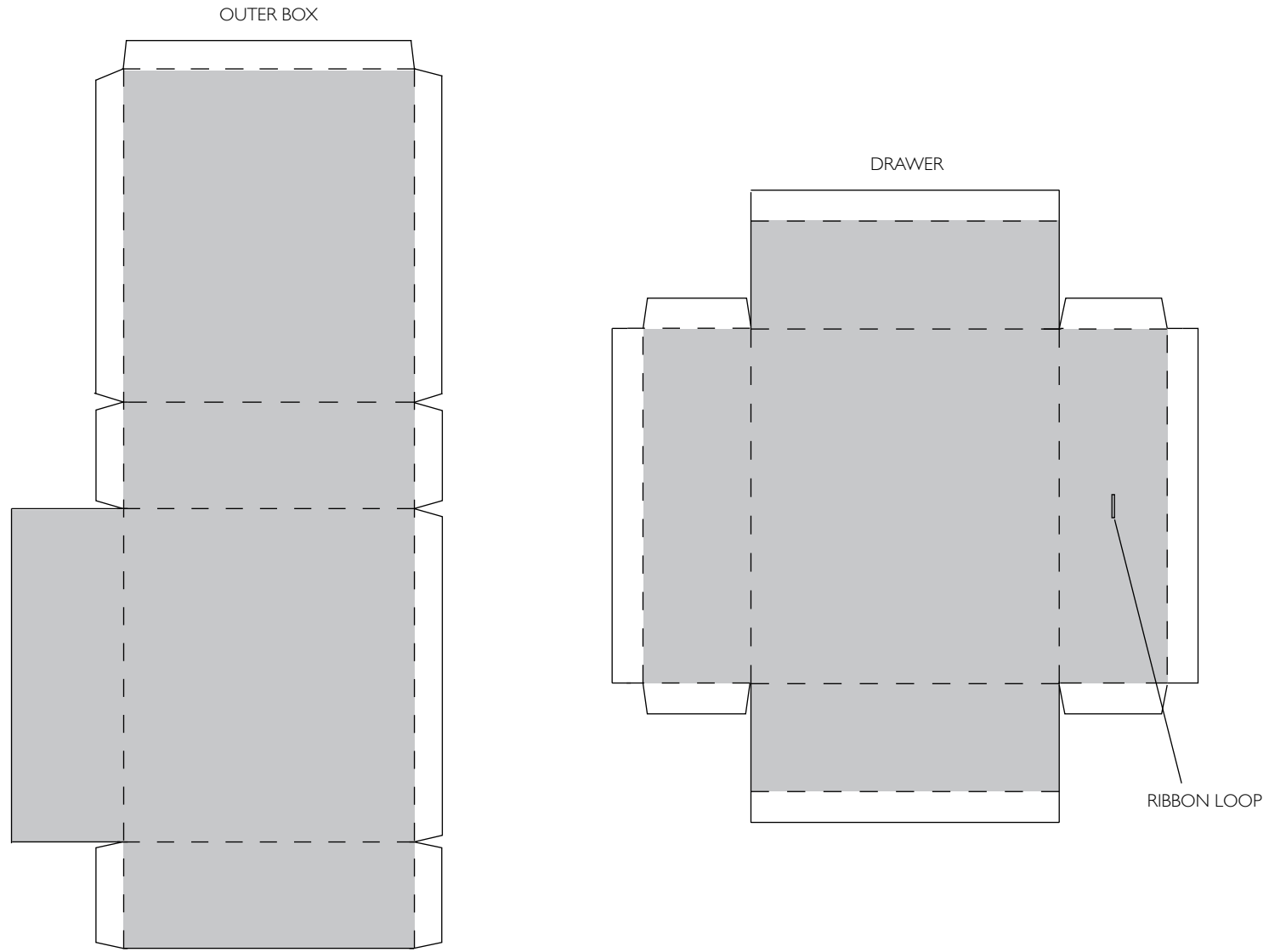



BUCKLE BOX

The Buckle Box is a simple closure system inspired by a belt buckle. The left and right flaps meet together and interlock when closed, and lifts one by one when opened for a unique unveiling experience. This closure utilizes hidden magnets to lock it in place.

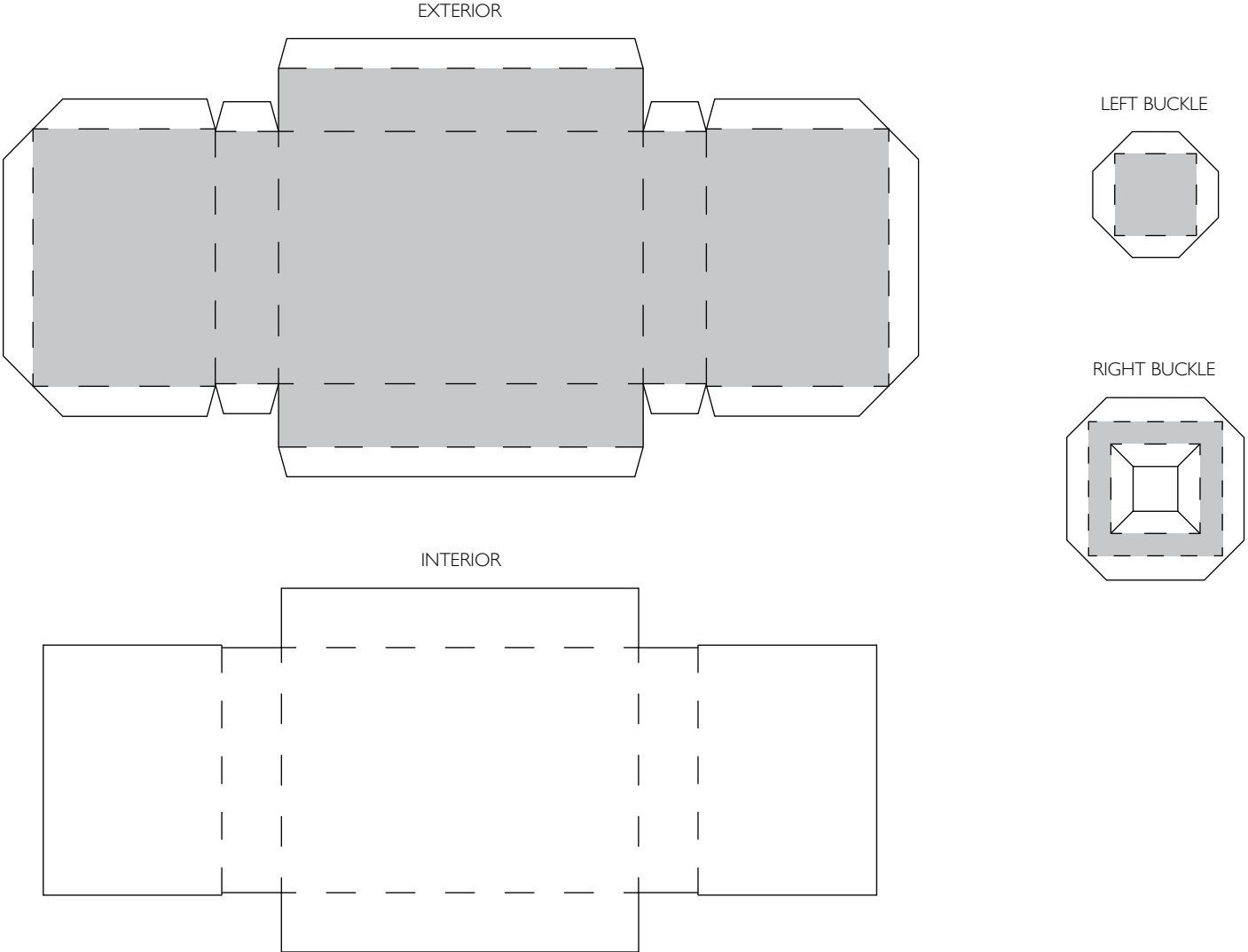

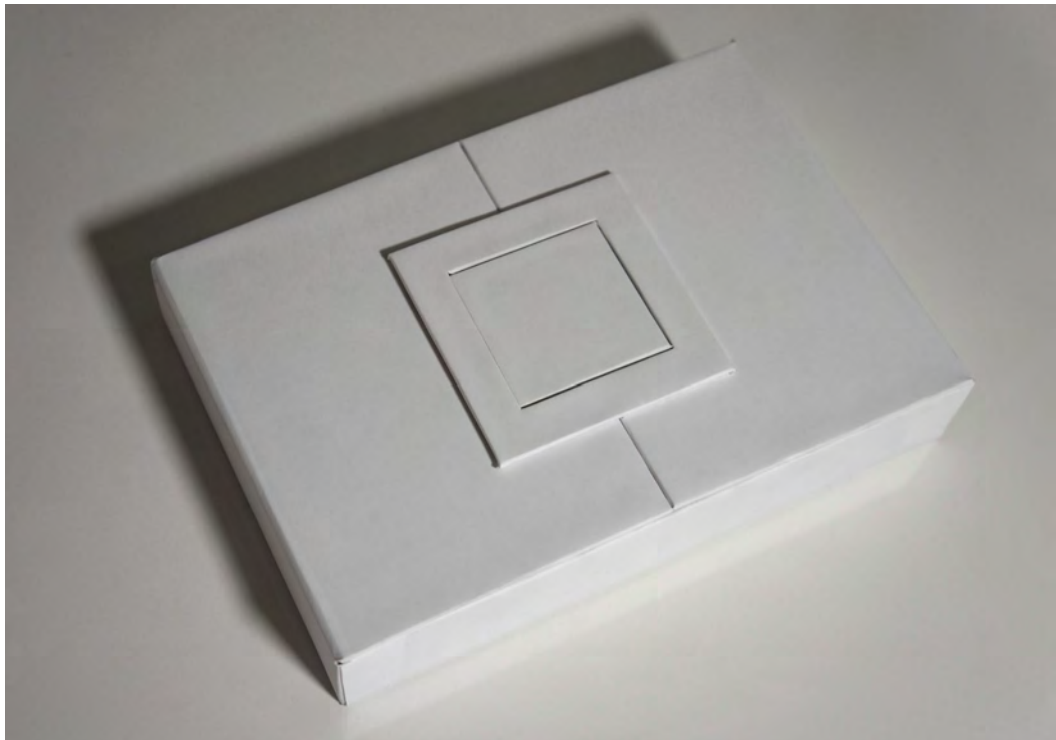
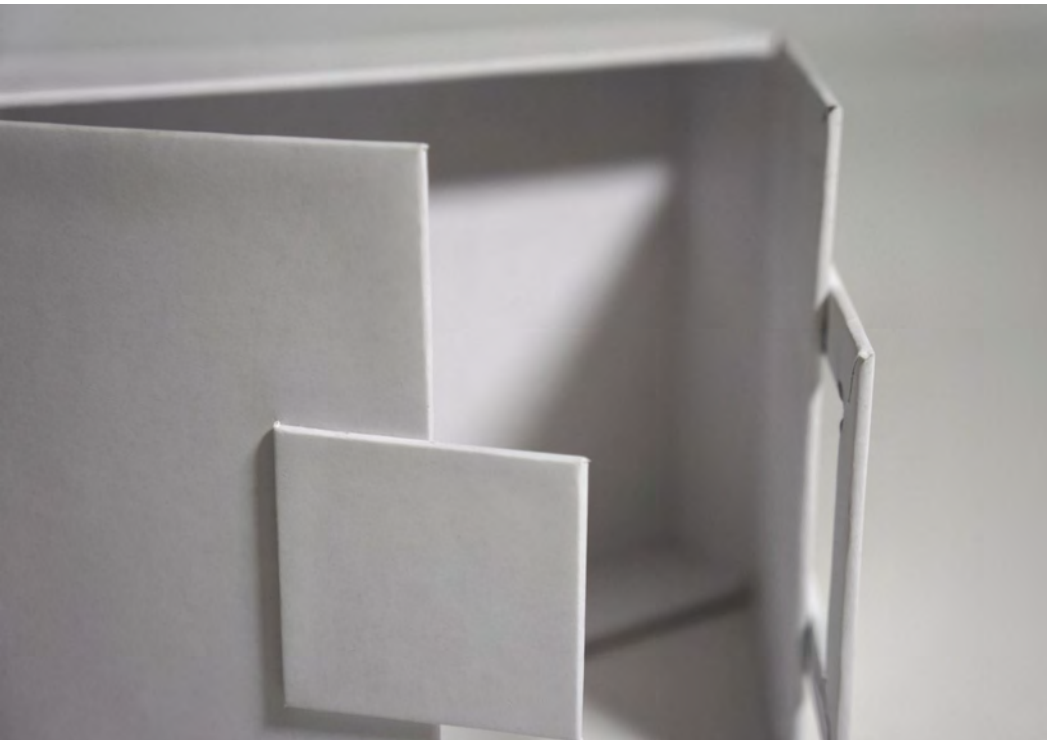
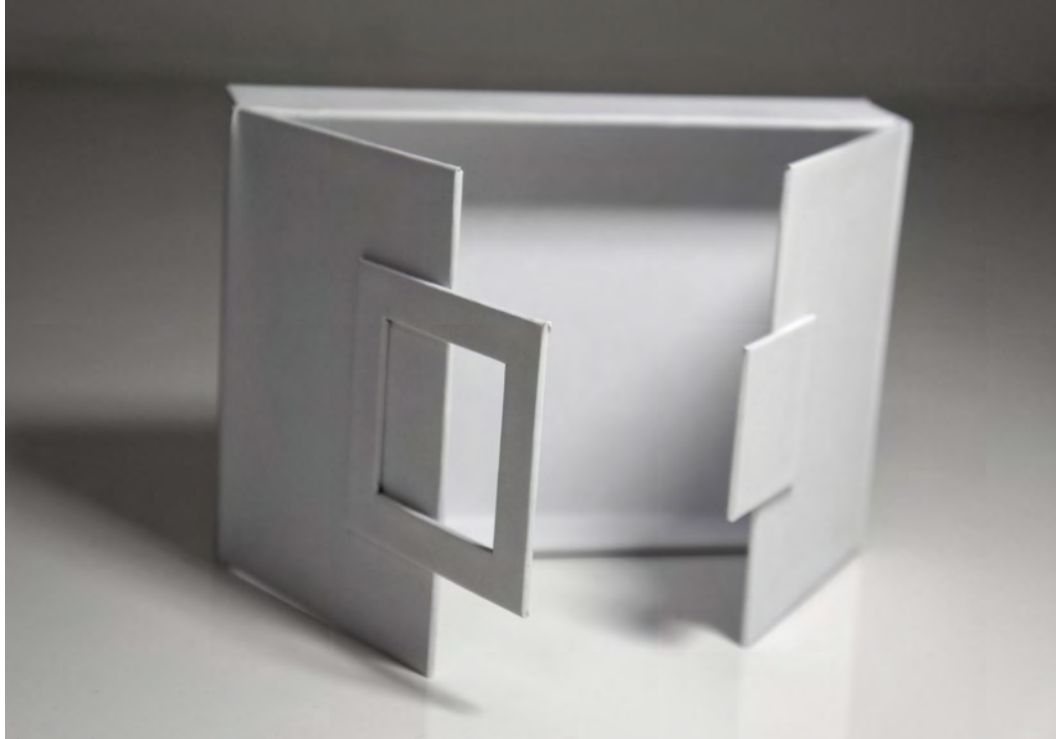
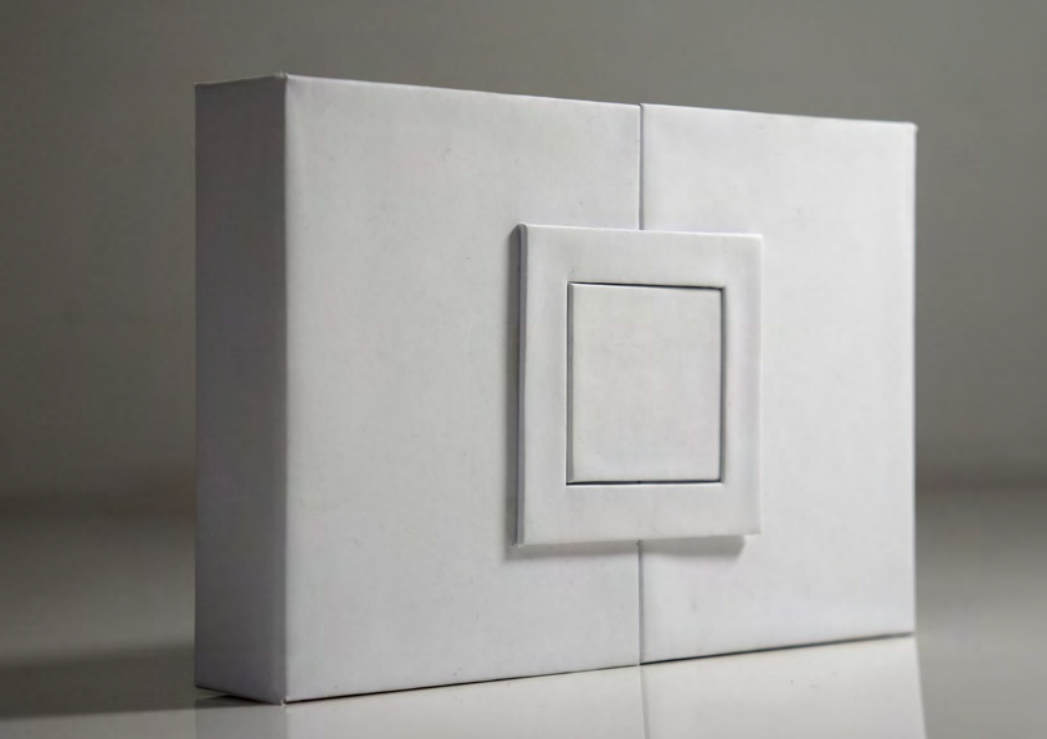

ANGLED CUFF RING BOX

The Angled Cuff Ring Box, is a simple evolution of the standard hinged ring box. The interior cuff allows the exterior lid and base to create this sharp, modern shape while the ribbon pull provides softness and interactivity.

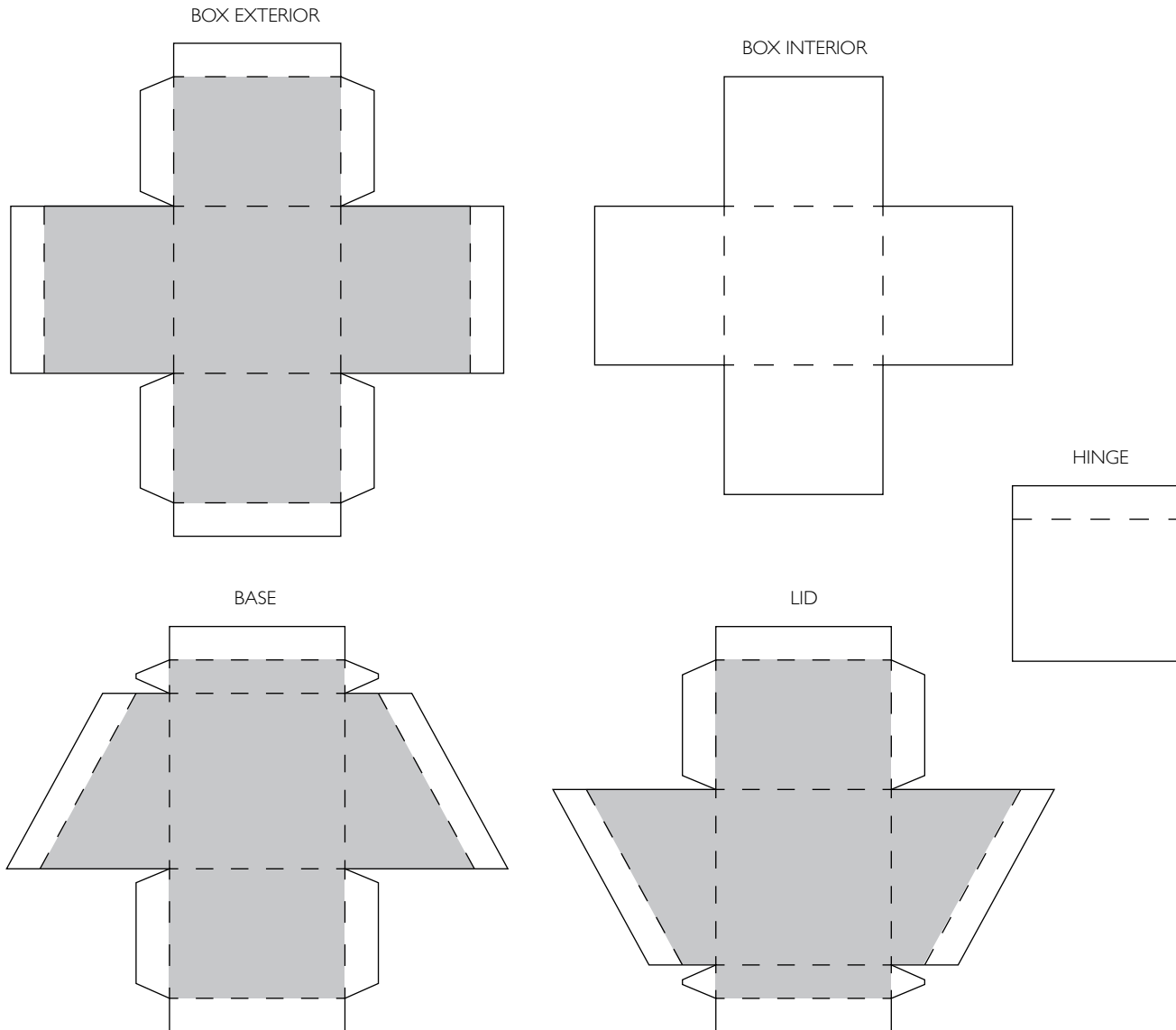

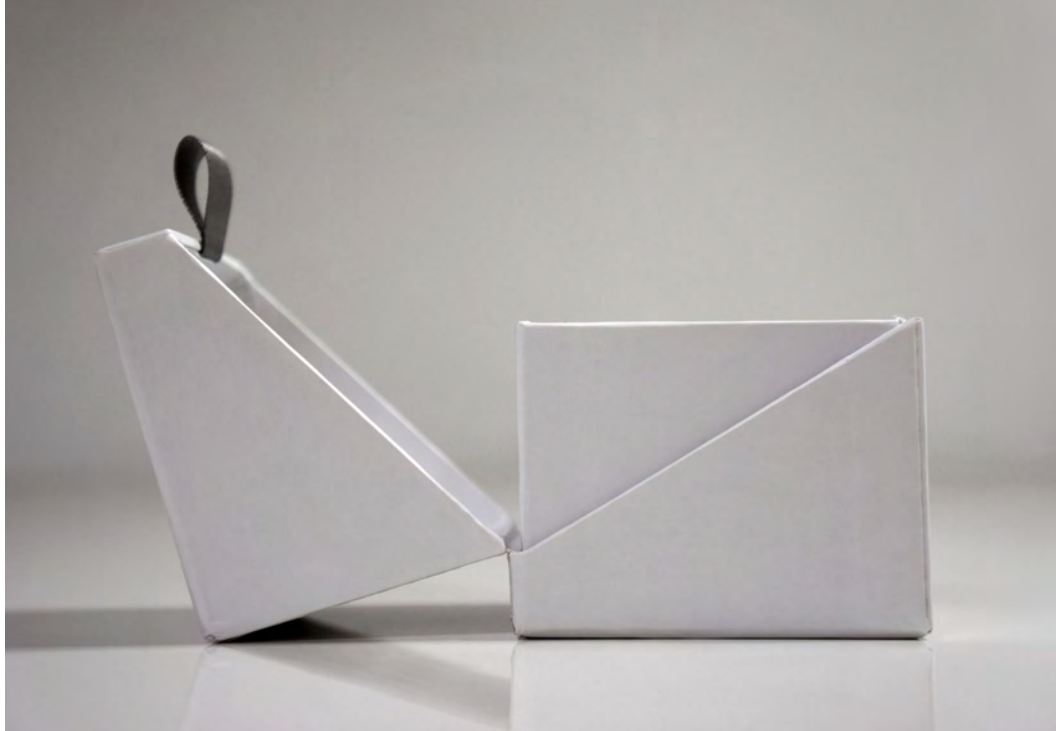

PEDESTAL BOX

The Pedestal Box is a two-piece construction that allows the product to be displayed and held securely on a platform for merchandising at retail, and provide a dramatic presentation when opened.

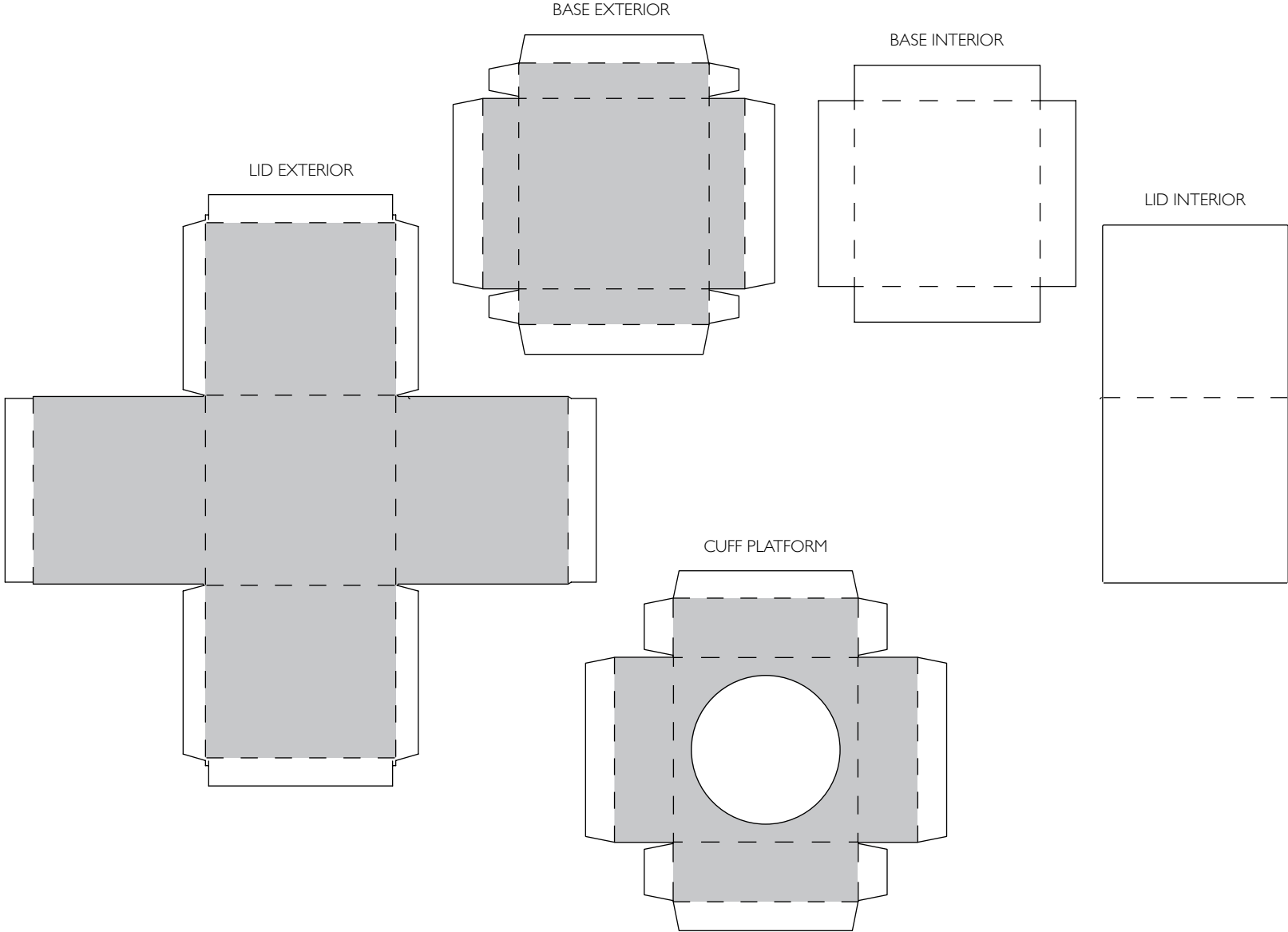

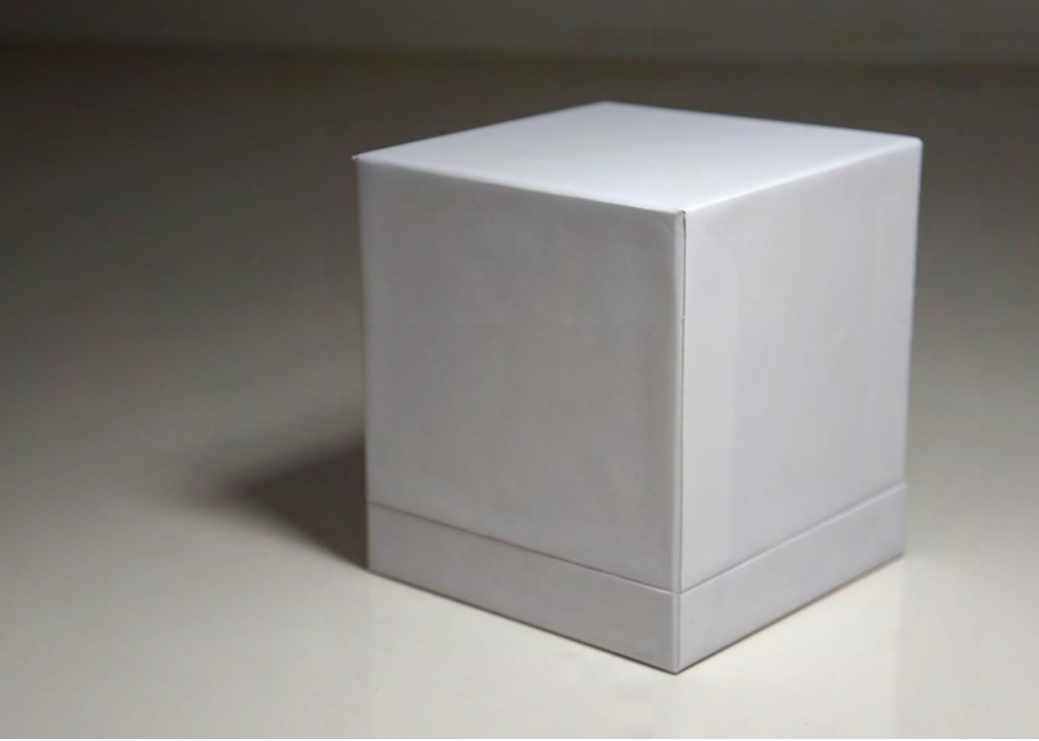

DRAWBRIDGE BOX

Inspired by drawbridge towers, this box can be designed with either a separate lid (pictured) or a hinged top that when opened, allows the front panel to be lowered by the user revealing the product.

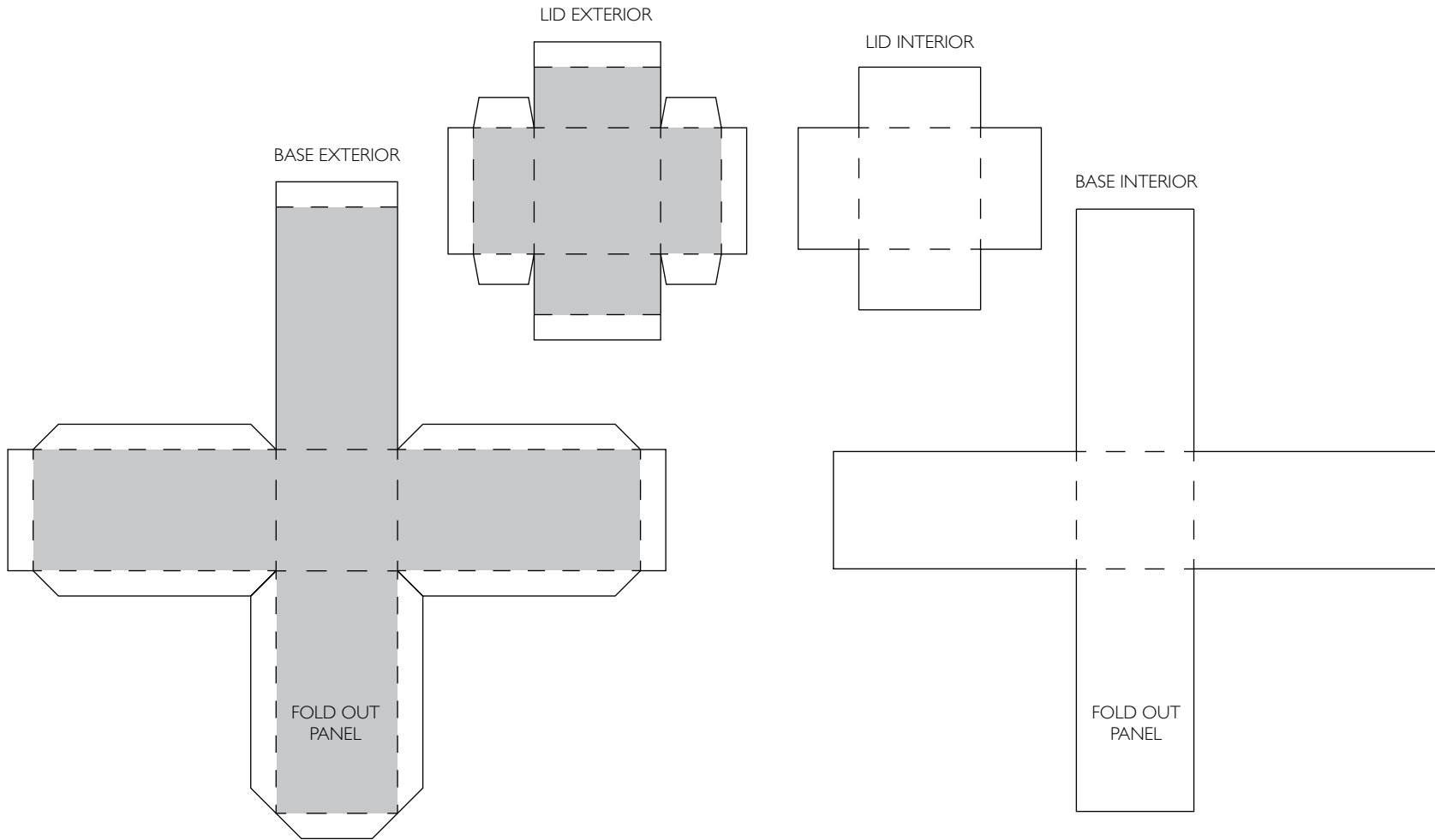

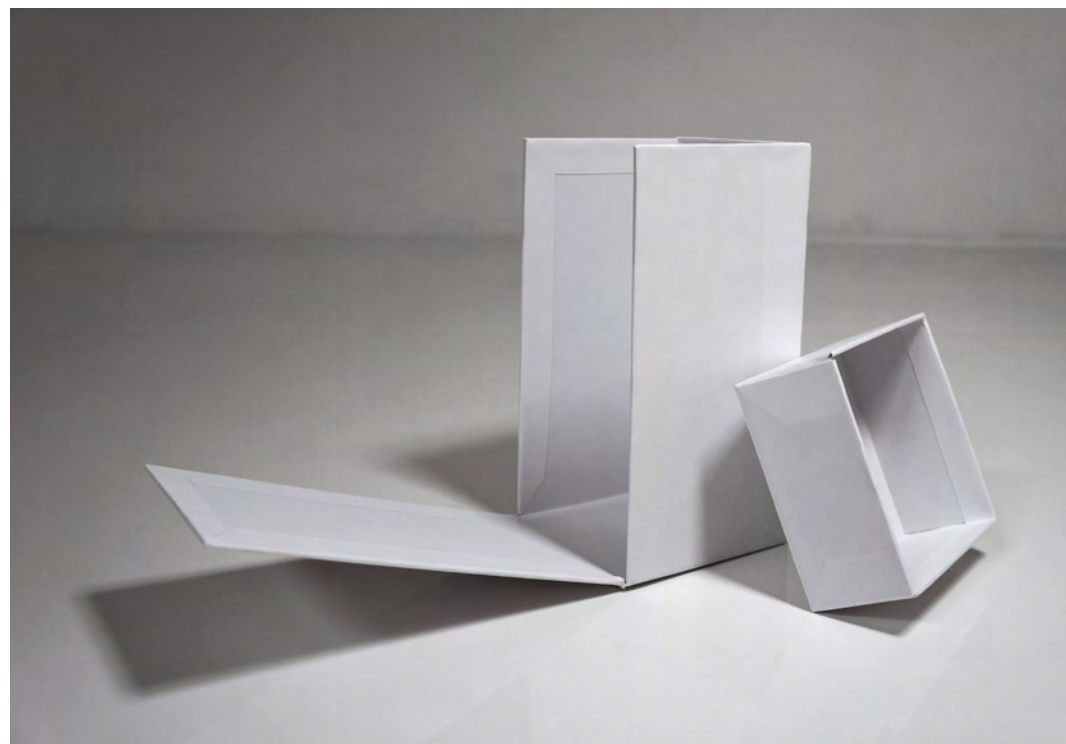
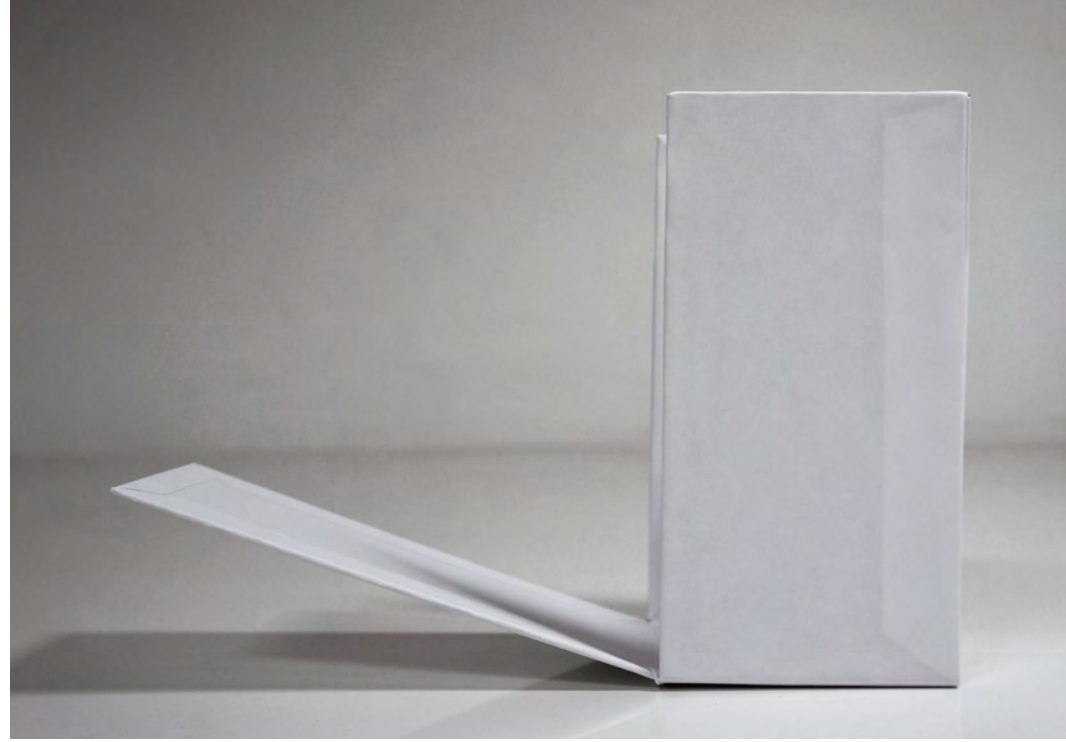
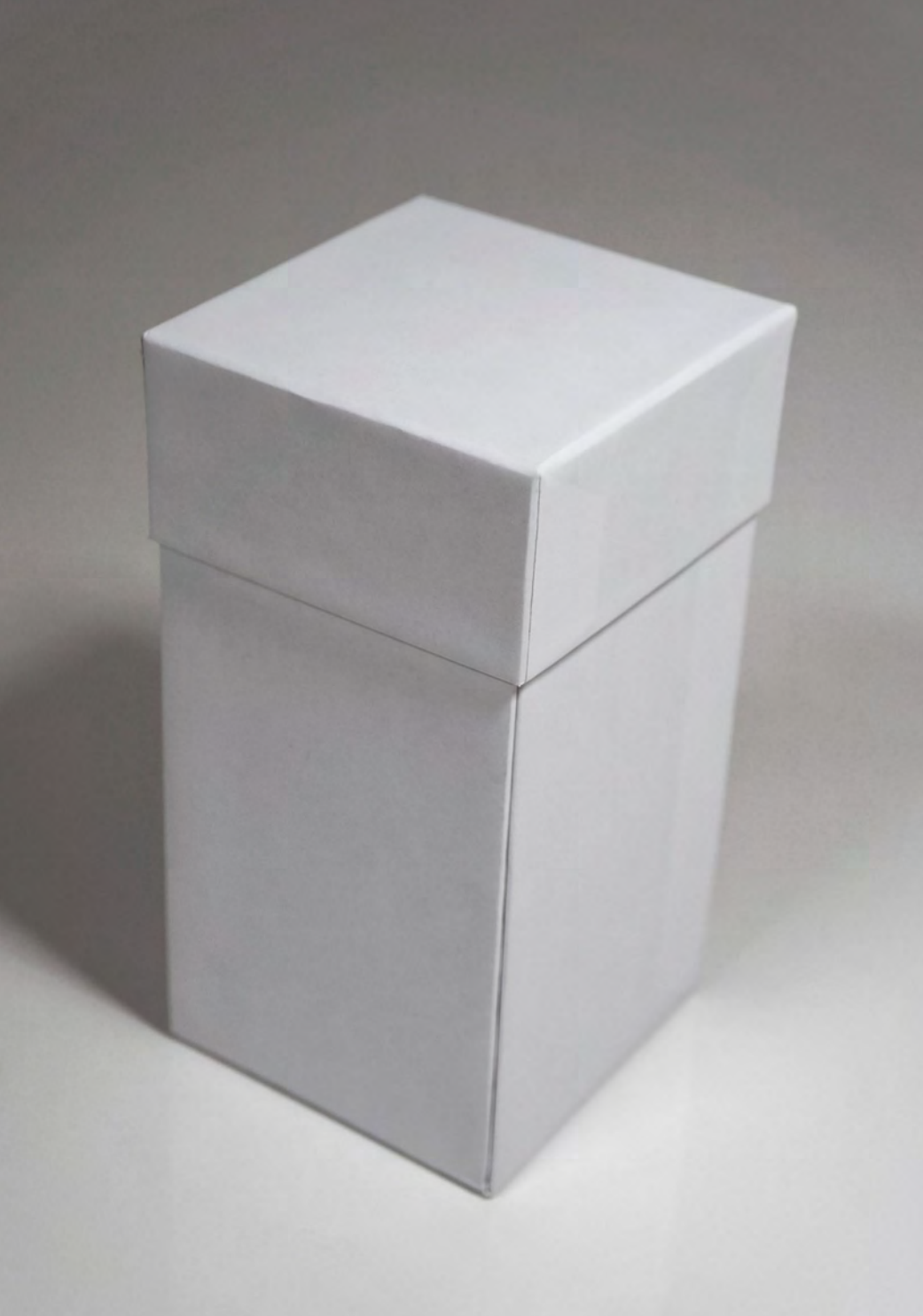

RIGID COLLAPSIBLE BOX

The Rigid Collapsible box is a space-saving solution that allows for a rigid box presentation, but with the convenience of a folding box. The box can stack flat behind the counter at retail, and popped open upon purchase.

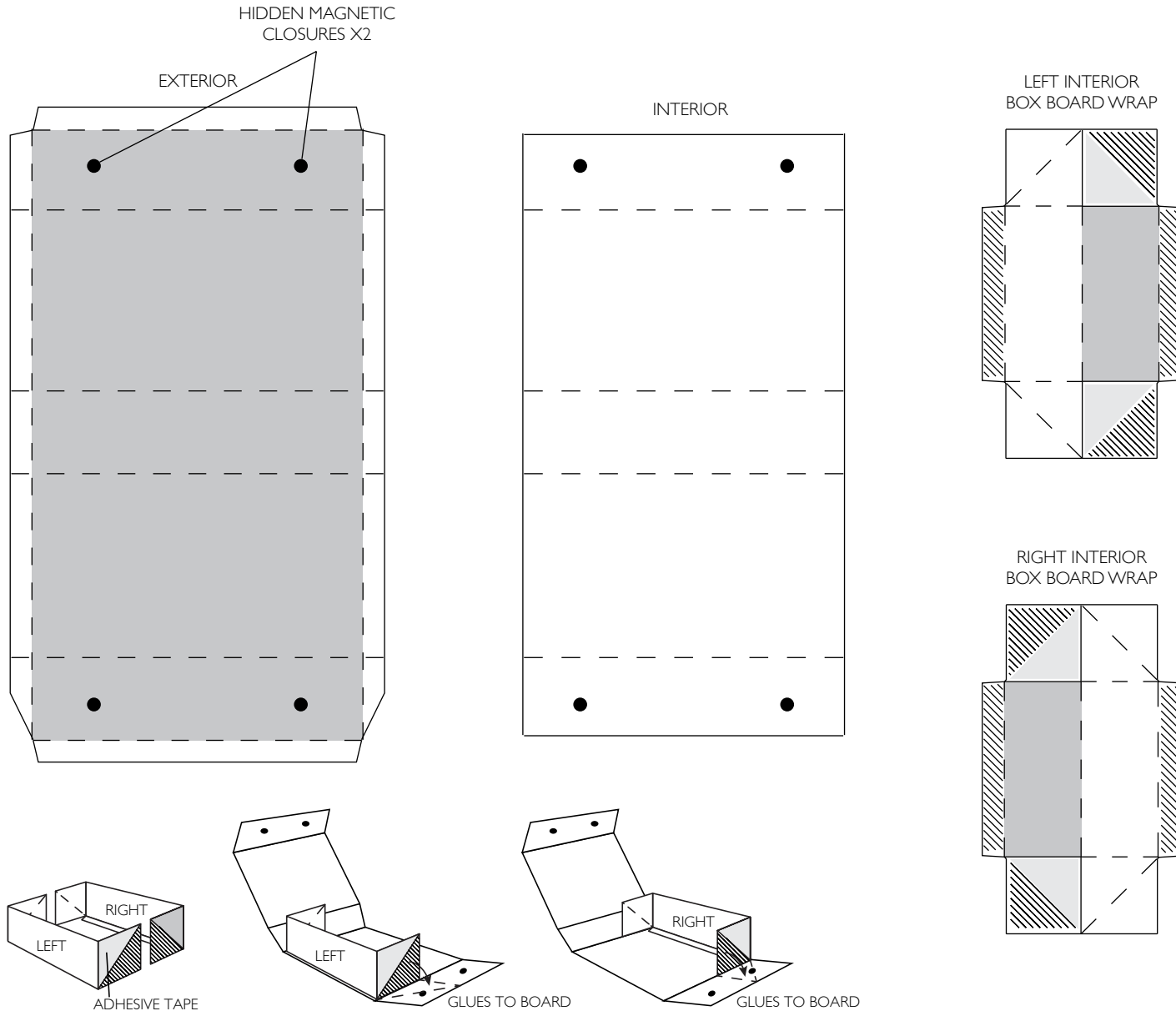

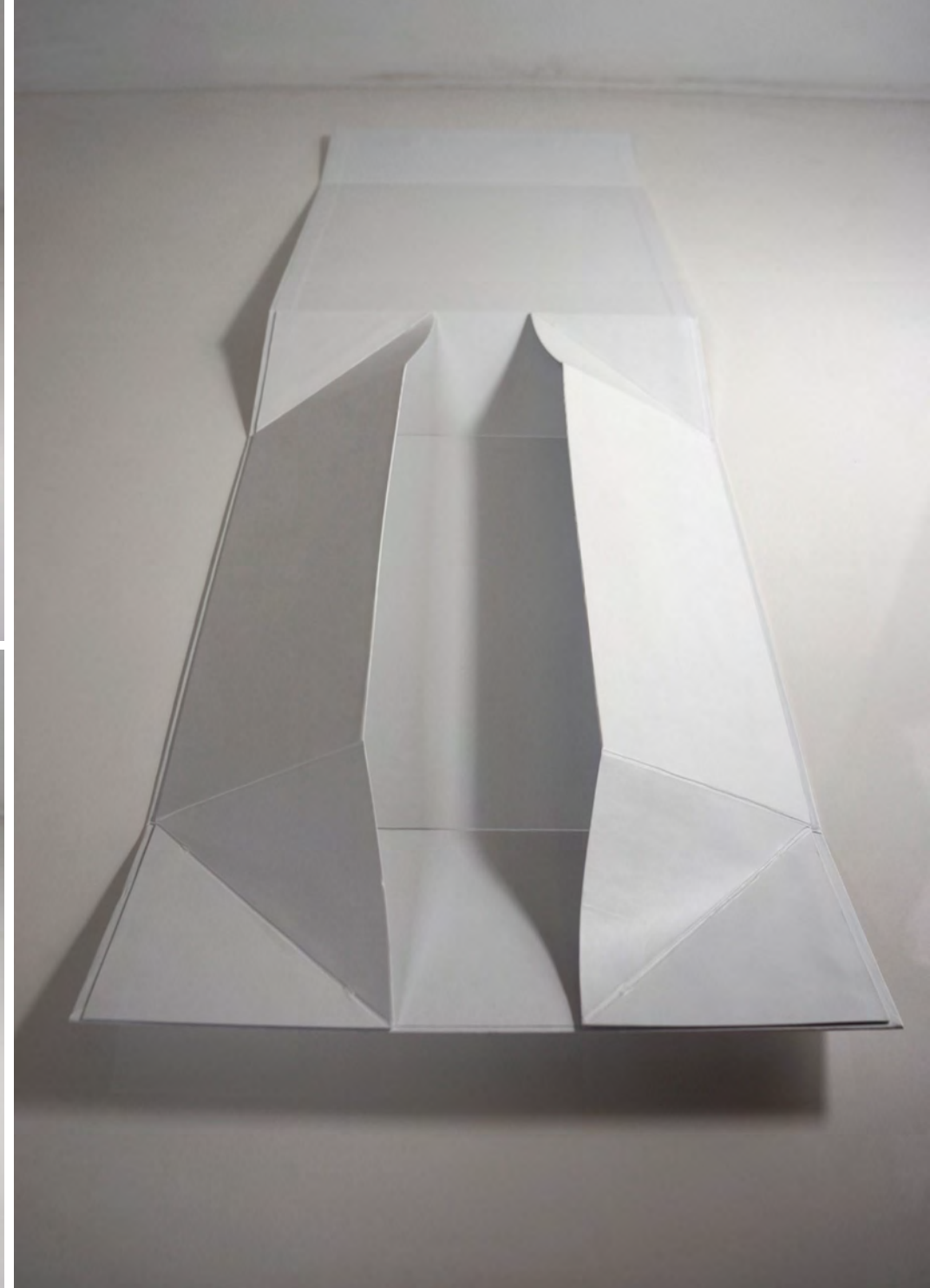
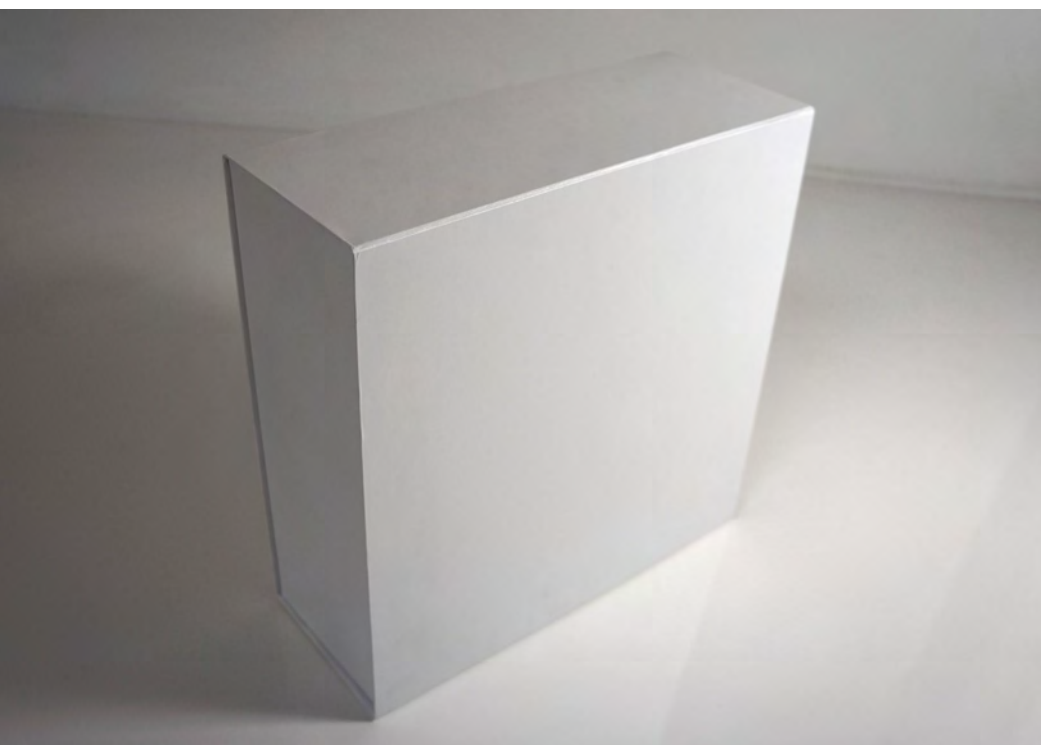

CUFF BOX

The Cuff Box is a two-piece construction with a cuff glued to the interior walls of the base that can either be exposed (pictured), or hidden within the lid to reveal the detail when opened.

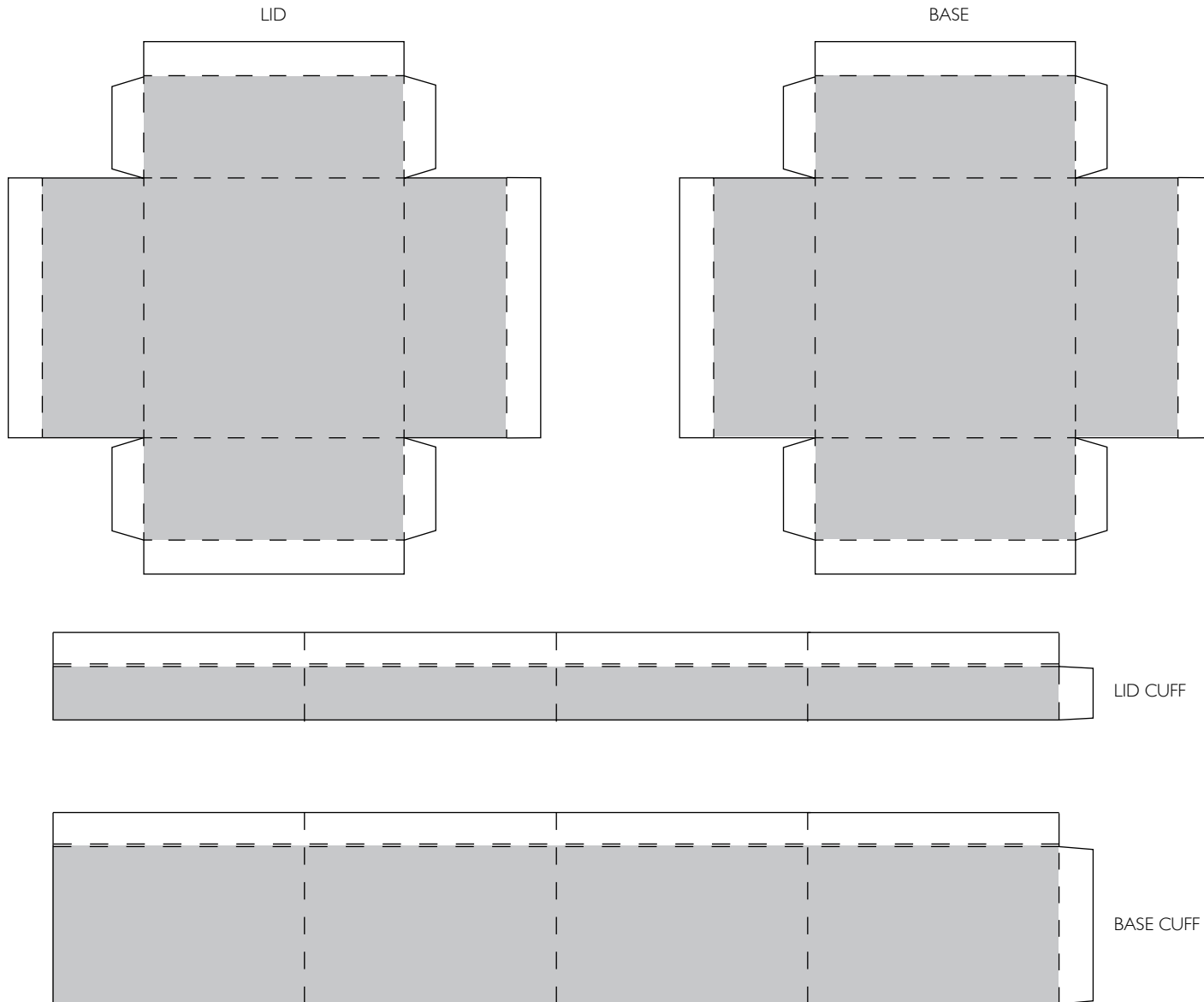

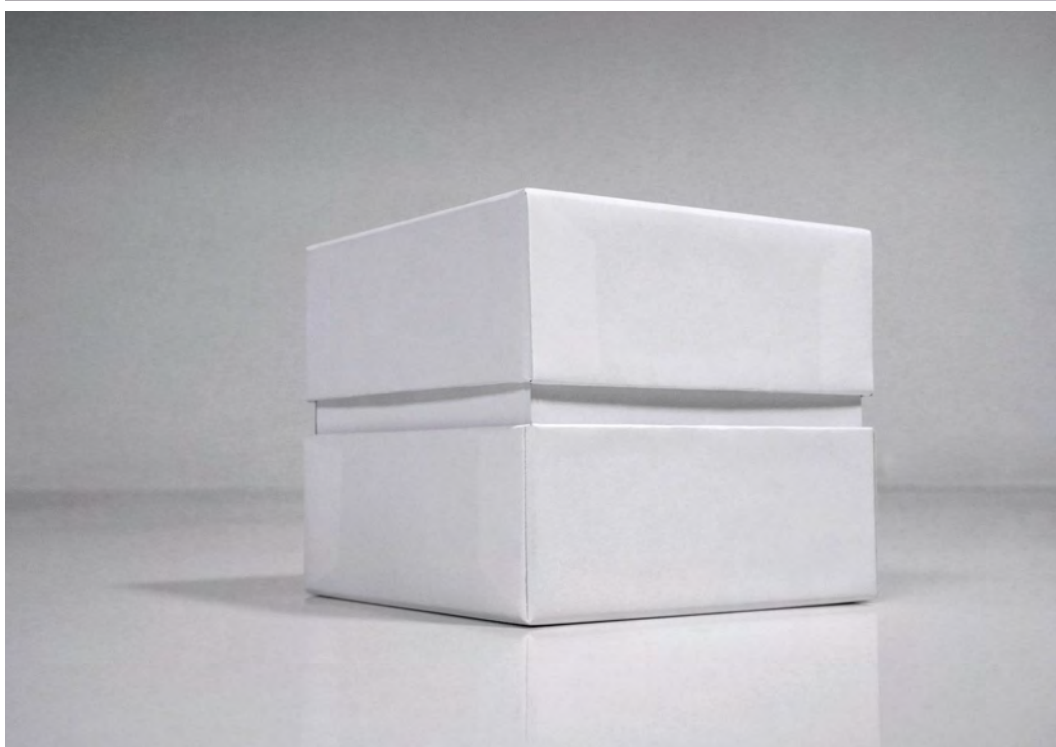

2-TIER BOX

What at first seems like a simple box, delivers it's layered impact upon unveiling. The top tray pulls away to reveal the contents of the bottom tray. The hinged construction delivers a dramatic display once opened.

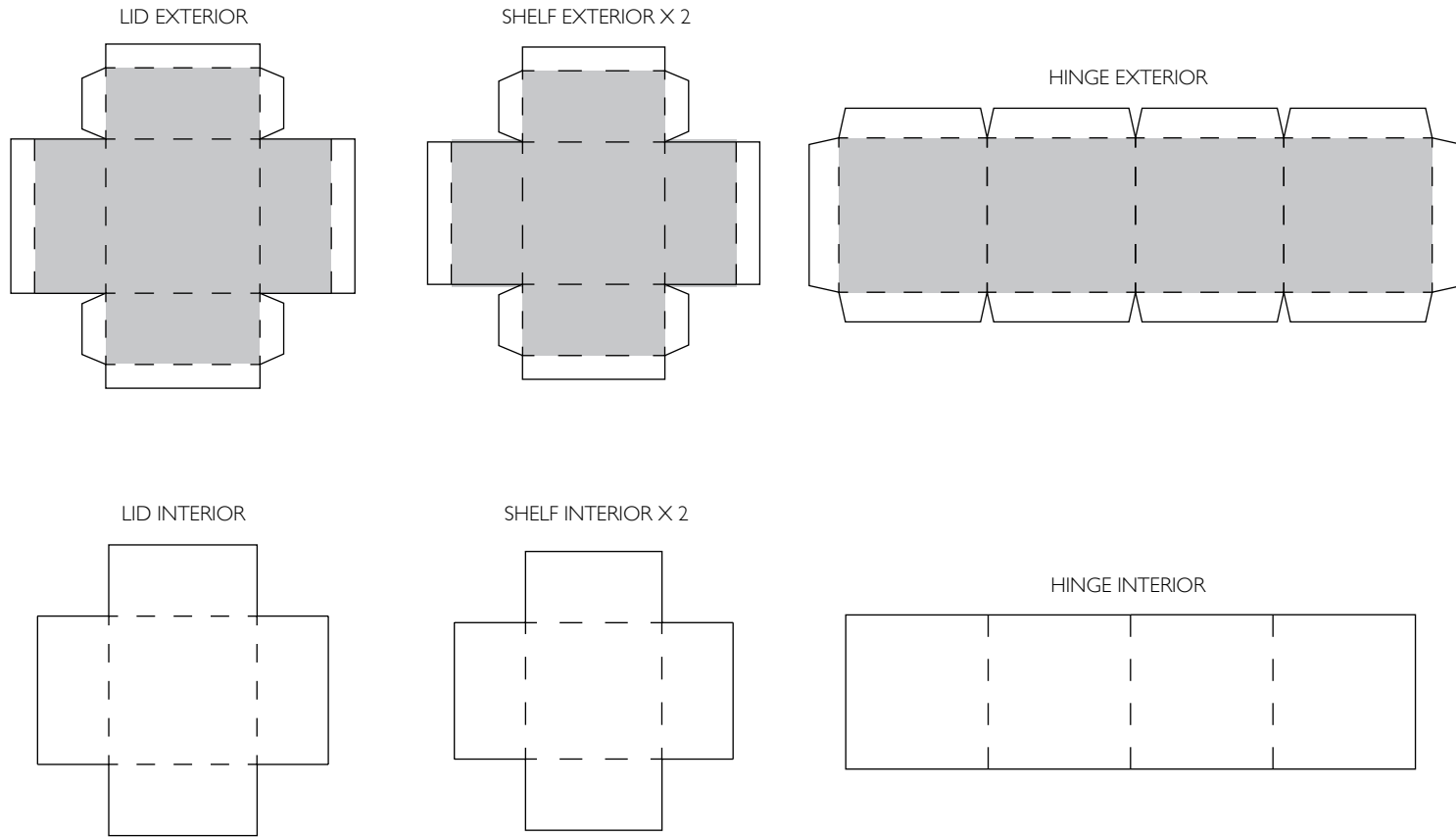





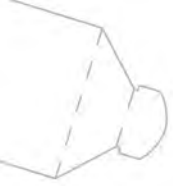

FOLDING BOXES

Folding boxes are typically used for secondary product packaging when competing on shelf for consumer attention. Folding boxes are a more cost effective option to rigid boxes because they use a card stock that can be directly printed and diecut. Card stocks come in various weights, and we recommend testing what works for your application before deciding on a final material. Stocks range from 10pt to 18pt and above in either coated or uncoated surfaces. We recommend that you always print out the dielines to confirm dimensions, proportions, user experience, and that the structure is what you envisioned prior to applying artwork.



ANGLED SIDE BOX

The Angled Side Box has a multi-faceted presentation that is able to collapse flat, and pop up easily for fulfillment. The front triangular surface provides an angled canvas for artwork that stands apart compared to vertical, flat boxes.

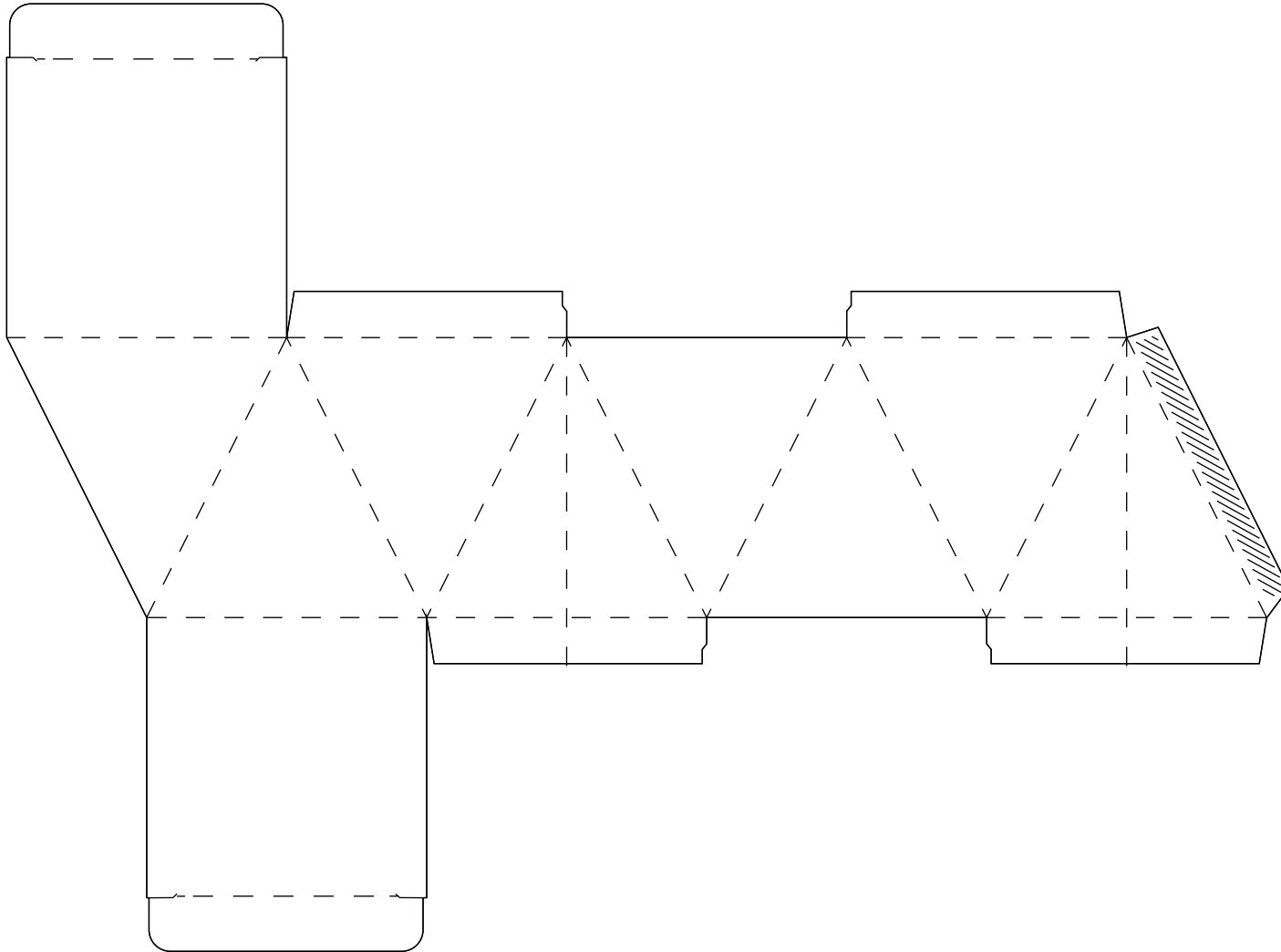

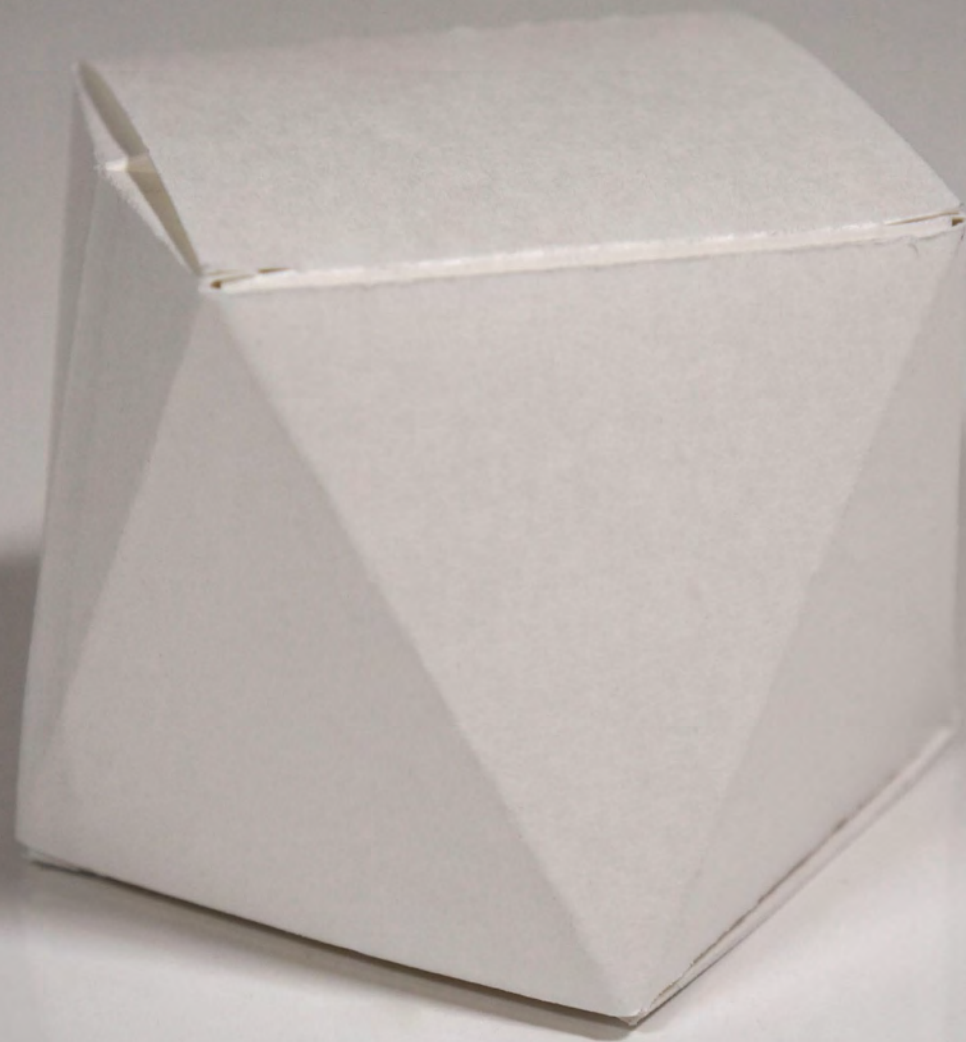

ANGLED SIDE BOX WITH HANDLE

A variation of the Angled Side Box (see previous page), is a taller version with handles. This construction also collapses flat and pops up easily for fulfillment.

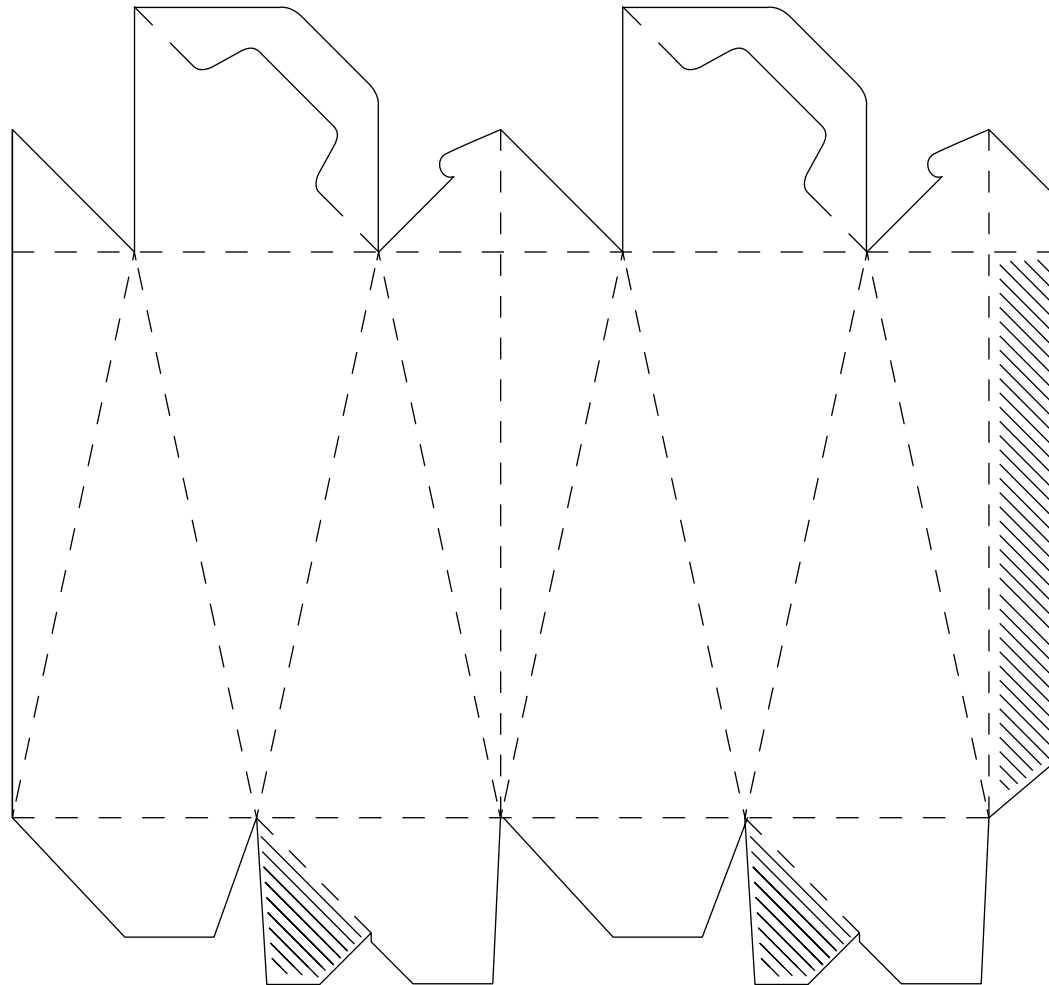



AUTO-LOCK BOTTOM BOX

The Auto-Lock Bottom Box is a construction that allows boxes to collapse flat and pop-up in one swift motion. The unique bottom construction automatically locks while providing strength and support to the weight of the product within.

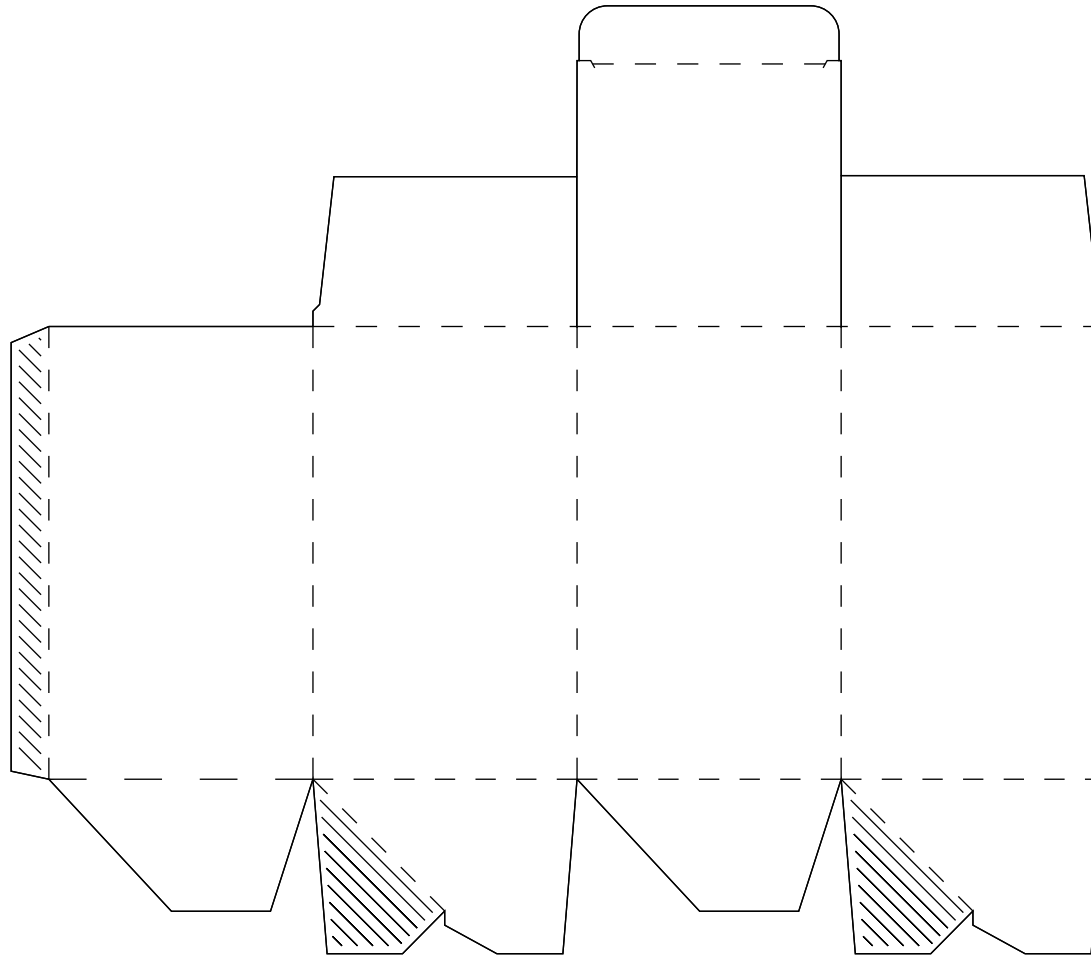

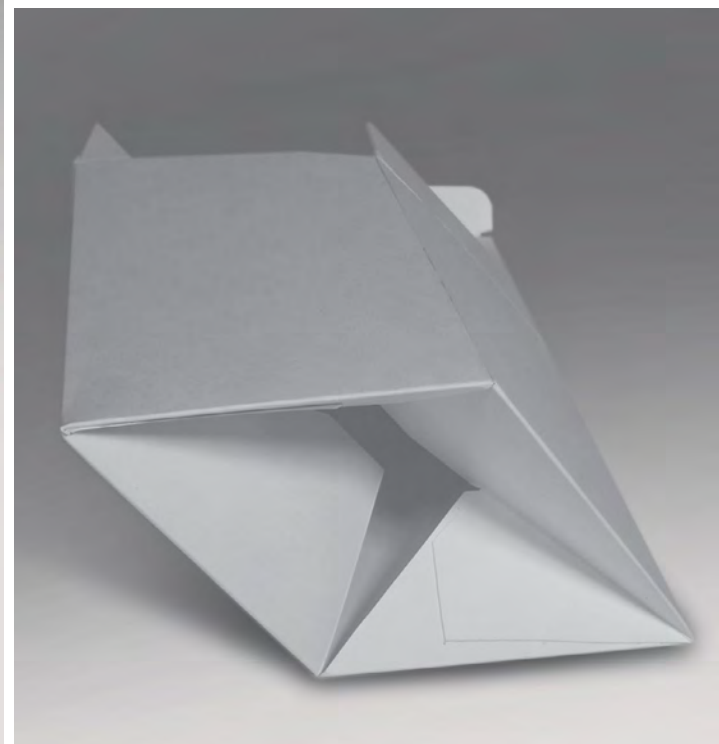

CHAMFERED CUBE

The chamfered cube presents the product through it's window and creates a dramatic silhouette. The chamfered bottom allows the box to be displayed in a 45° with an angled front panel, rather than the standard 90° with vertical panel.

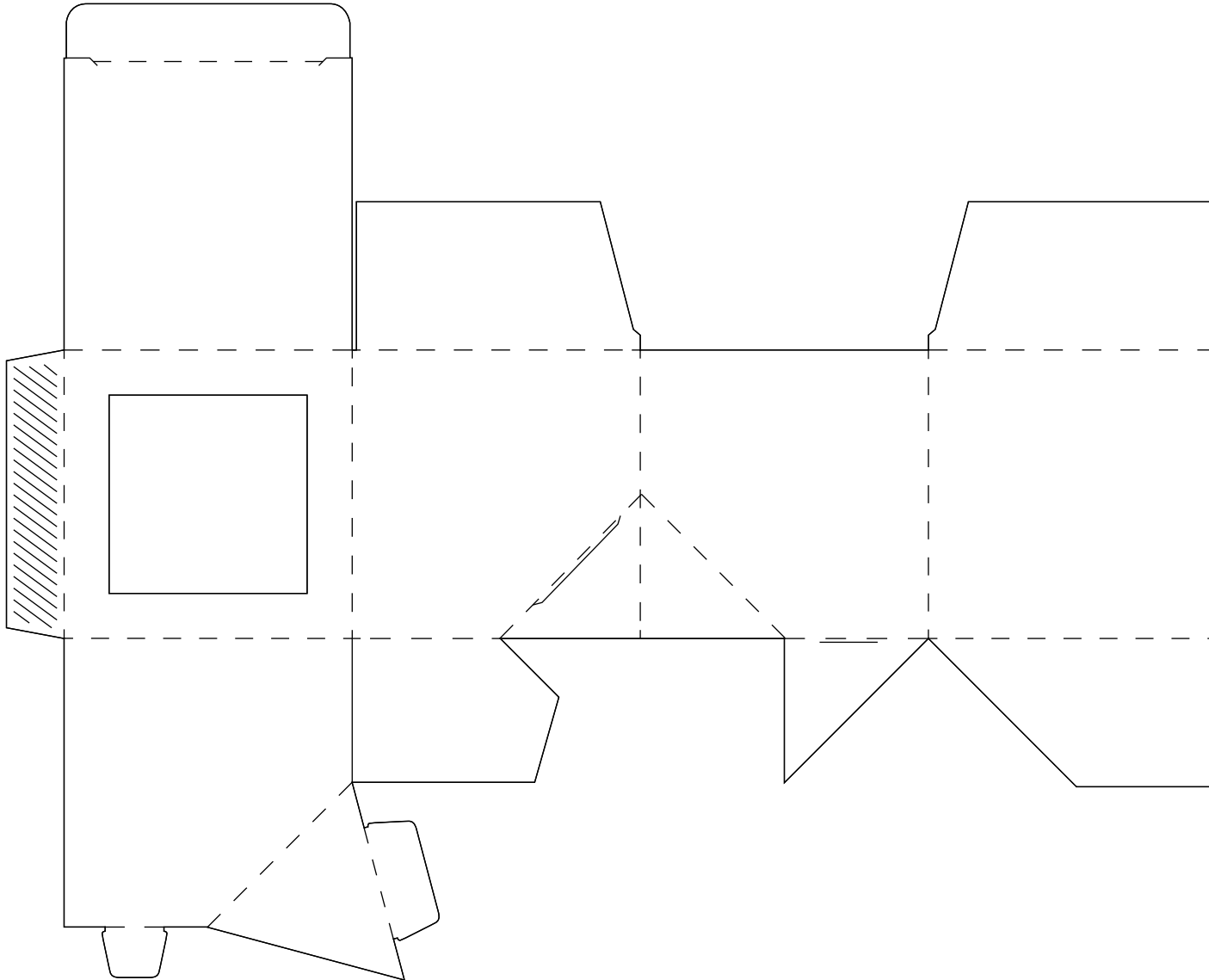

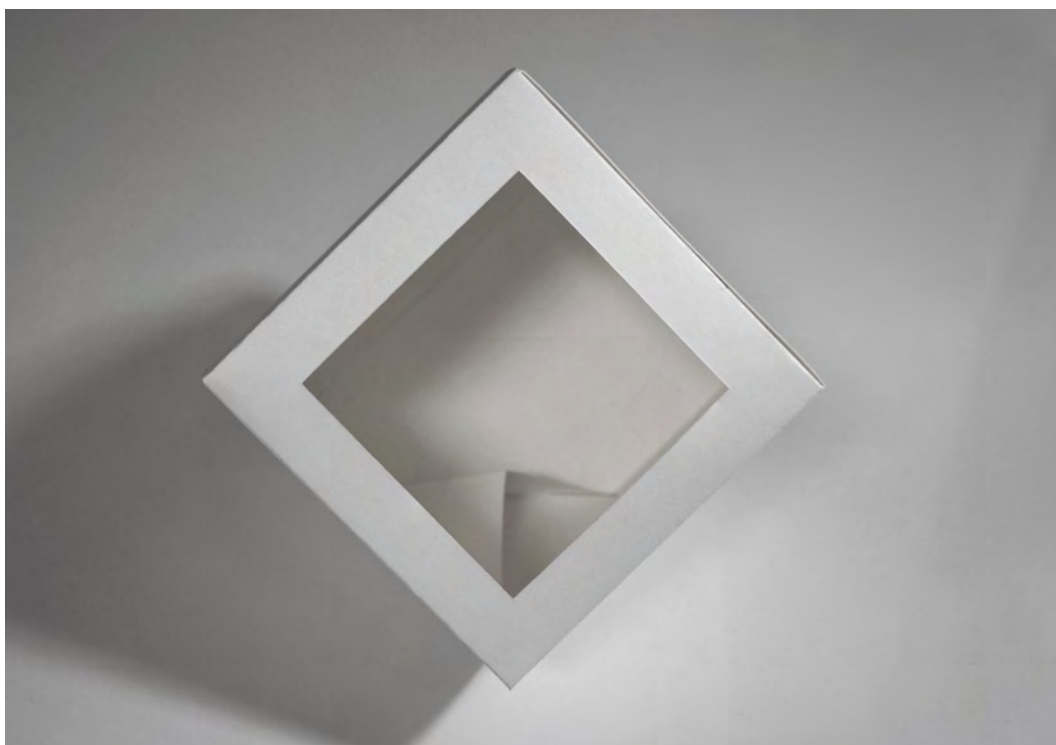
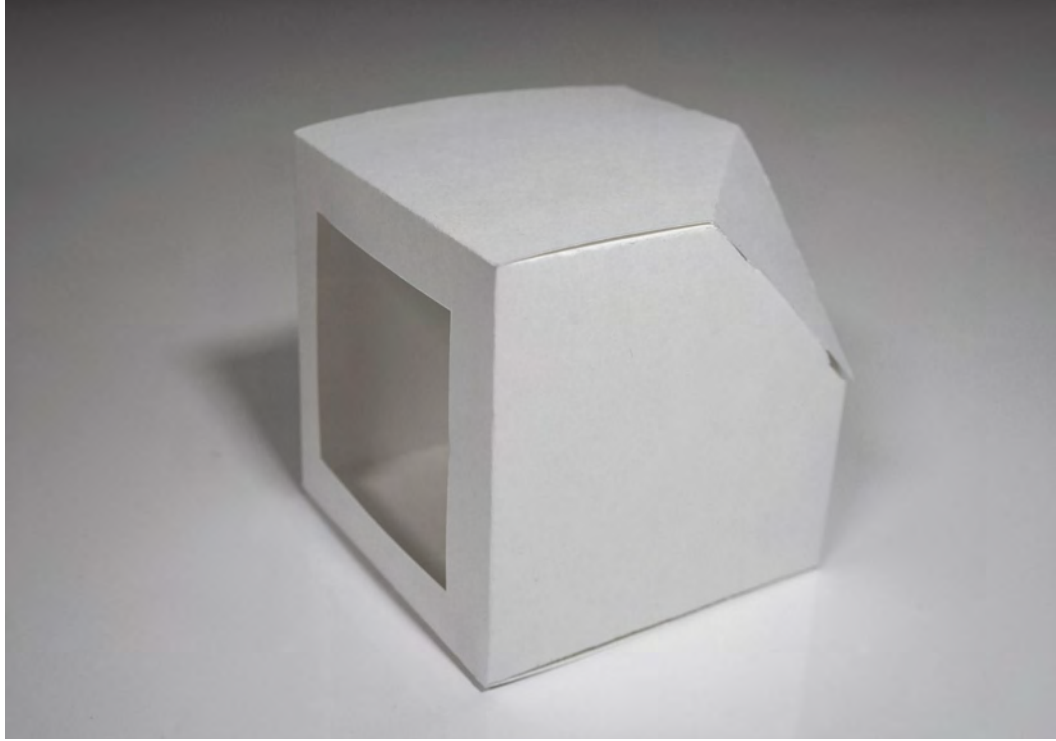
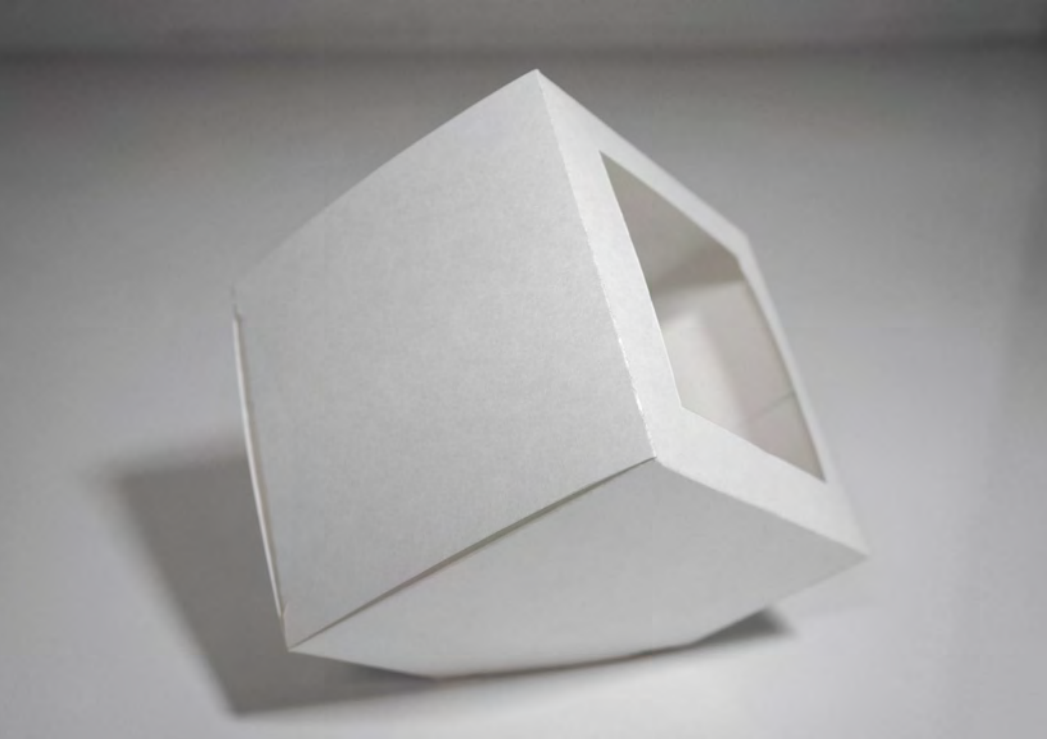

COMPOUND SIMPLEX BOX

The Compound Simplex Box is often used in retail as gift packaging due to its simple lid and base pop-up construction. Two of the side panels fold up, while the other two panels are folded in and secured by notches built in to the die lines.

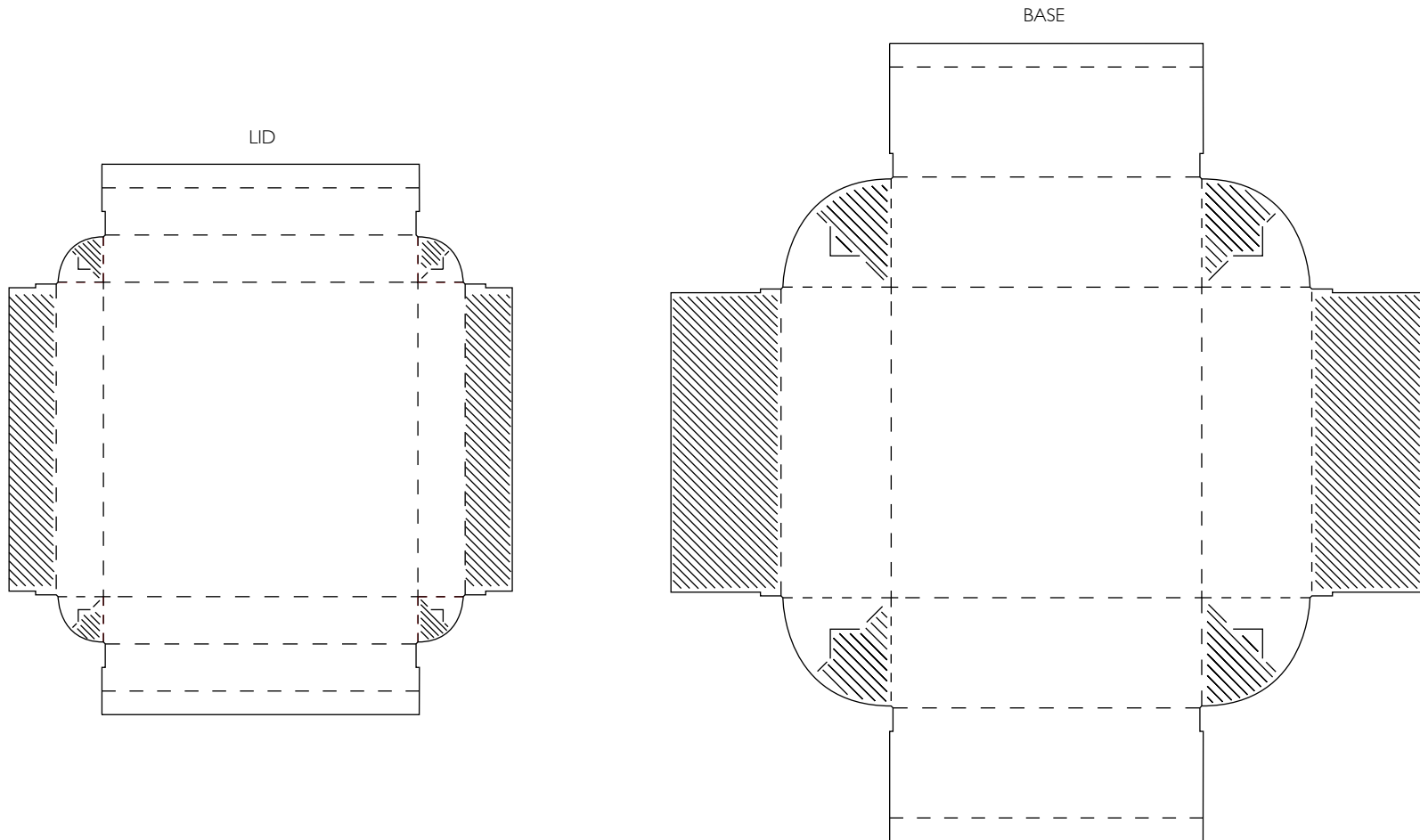



CURVED SIDE BOX

The Curved Side Box is an evolution of the standard tuck-top boxes presenting itself with curved facets, folds, and angled footprint.

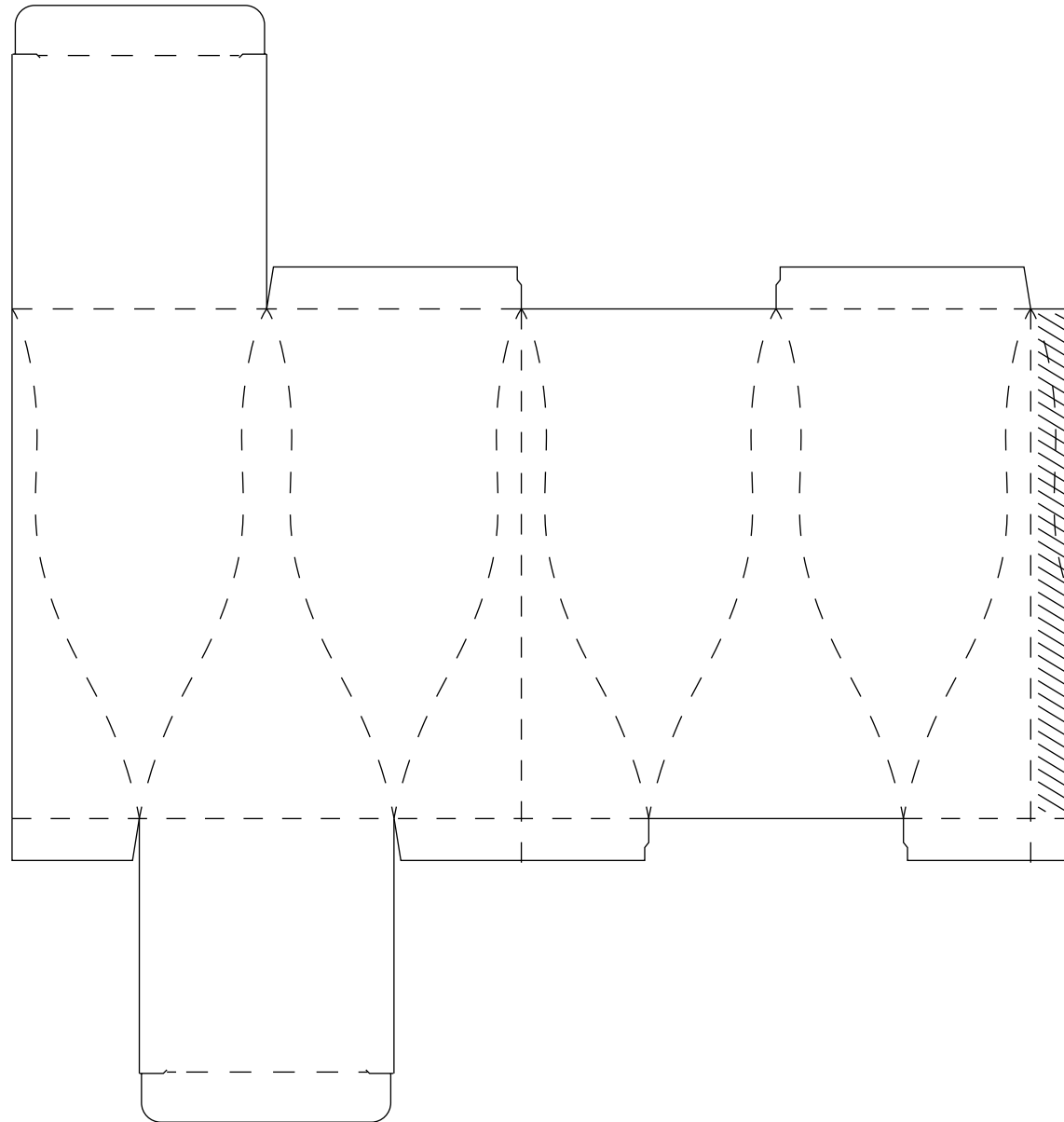



CURVED SIDE BOX II

This Curved Side Box II is a variation of the previous curved side box presenting itself with more cathedral facets, folds, and angled footprint.

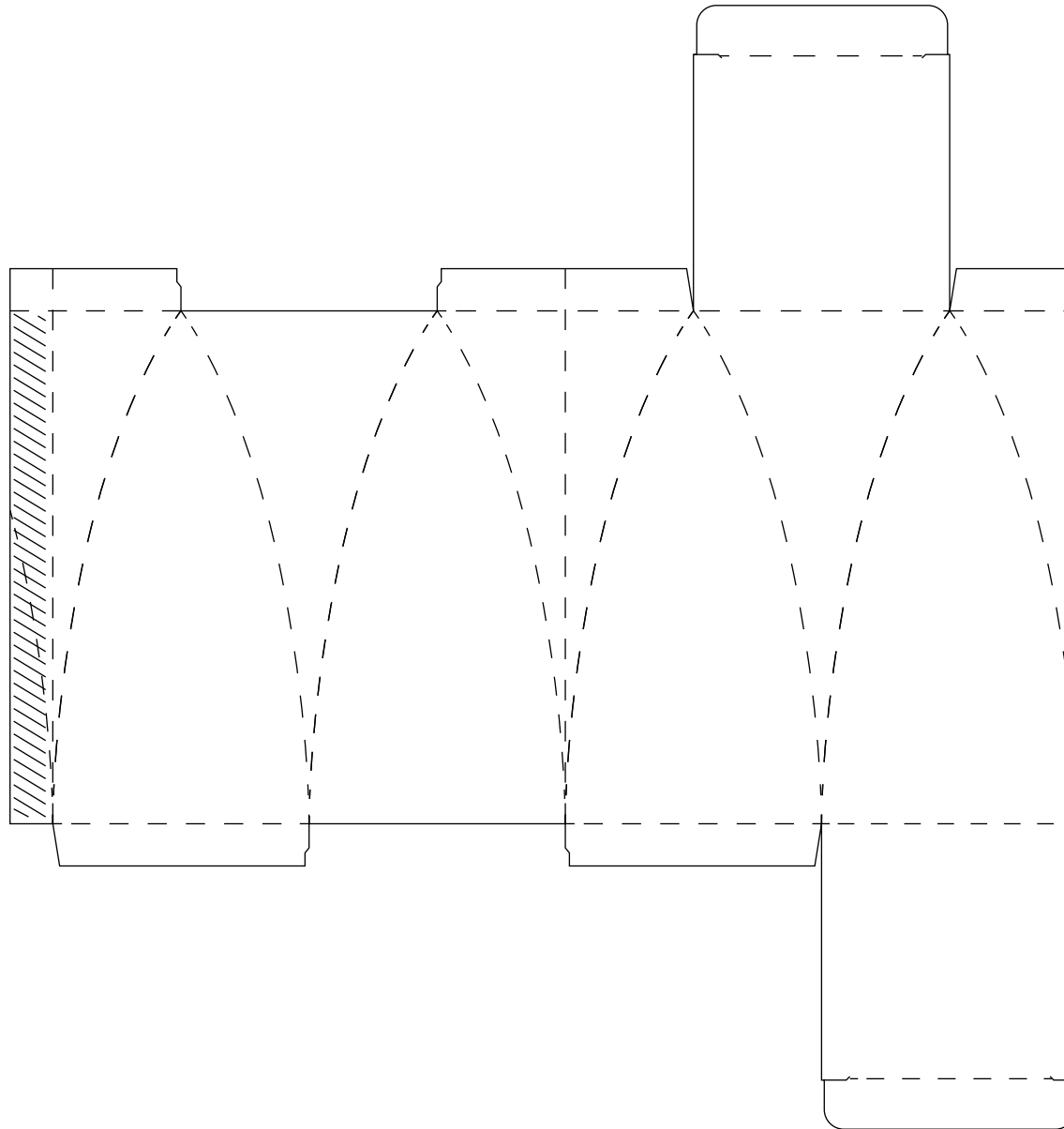



DOUBLE-FOLDING BOX

The Double-Folding box creates two separate compartments under one lid and base that can be scaled individually.

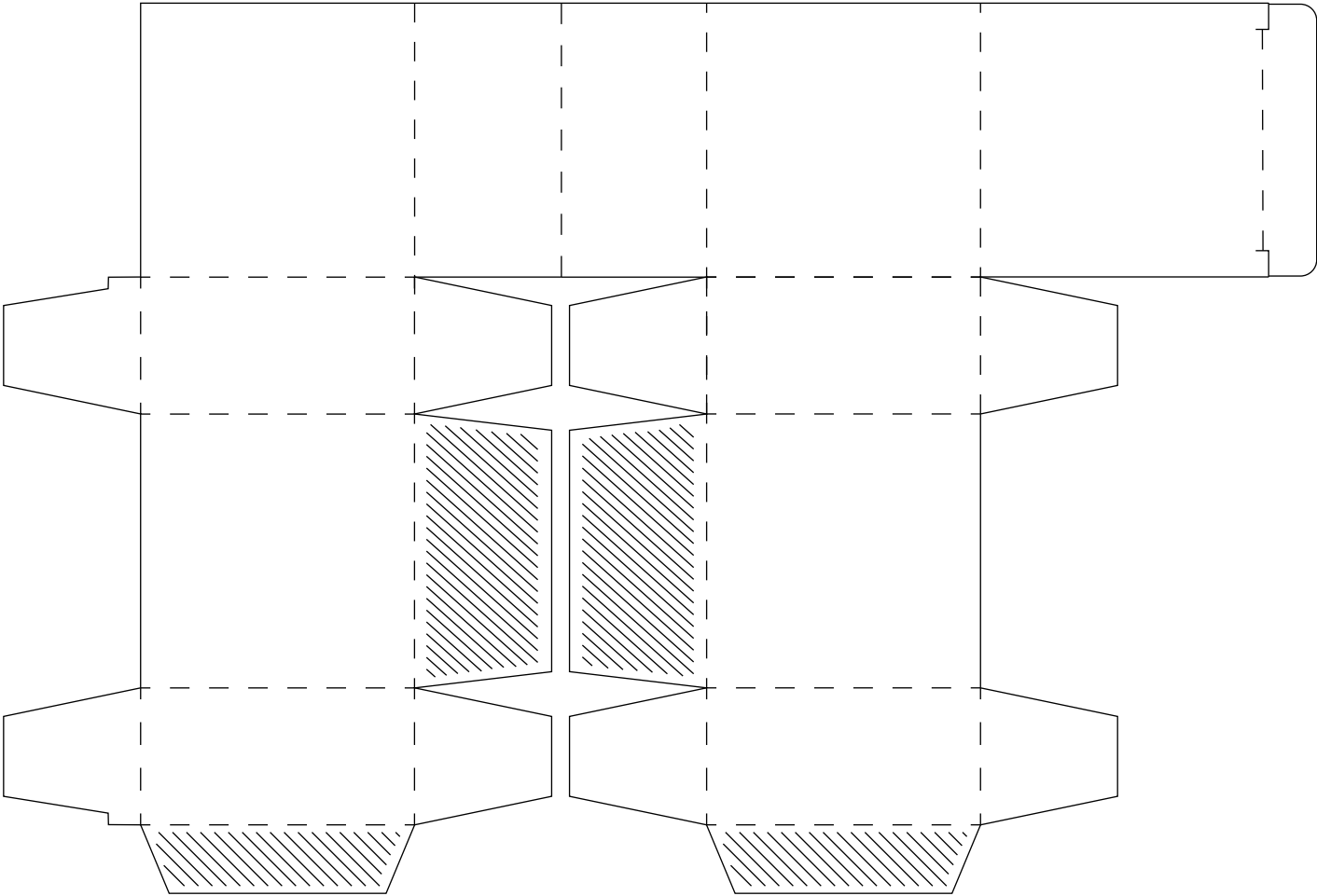

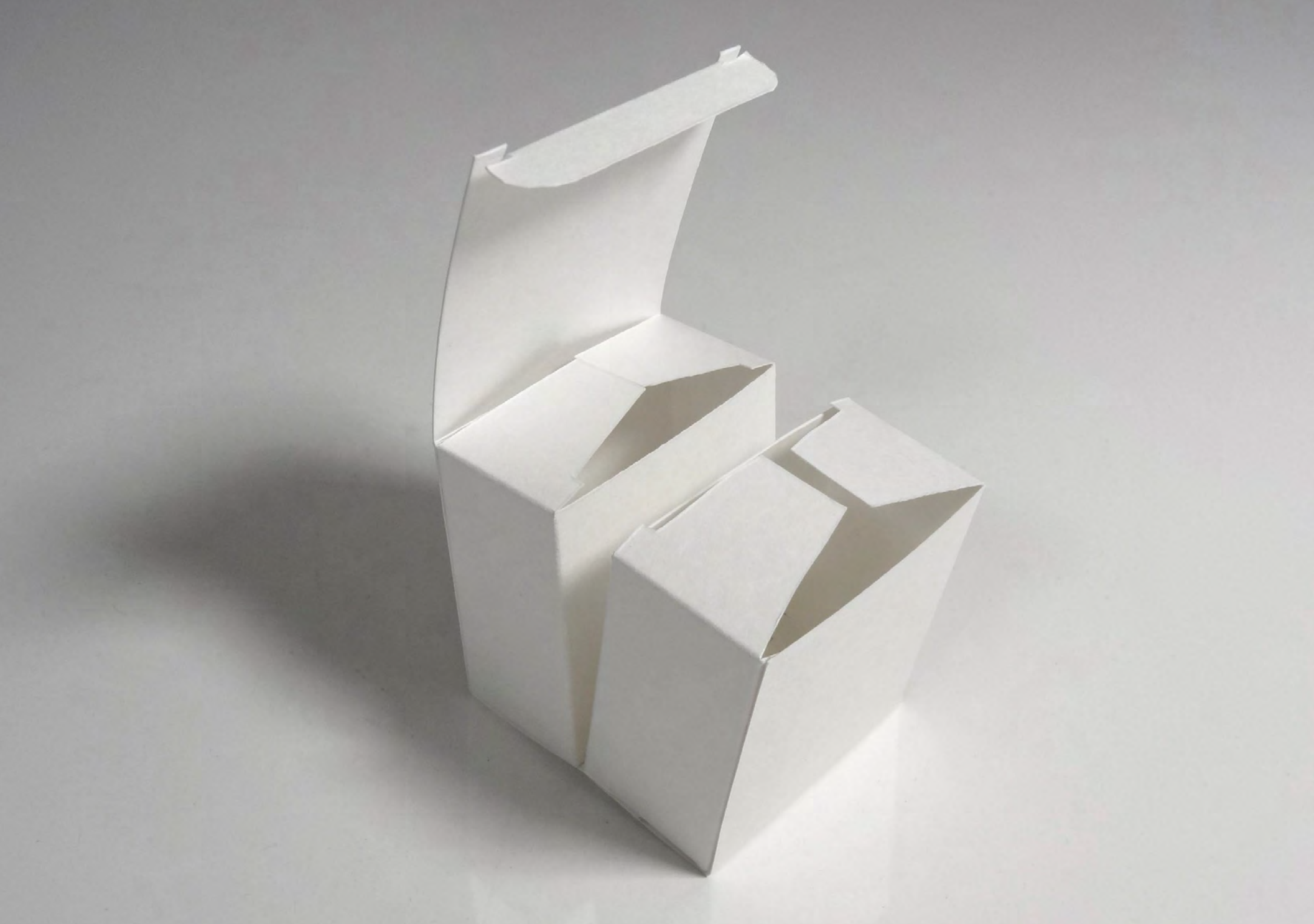

HOUSE BOX

The house box remains closed by interlocking the flaps on it's roof that can be easily opened to reveal the product inside.

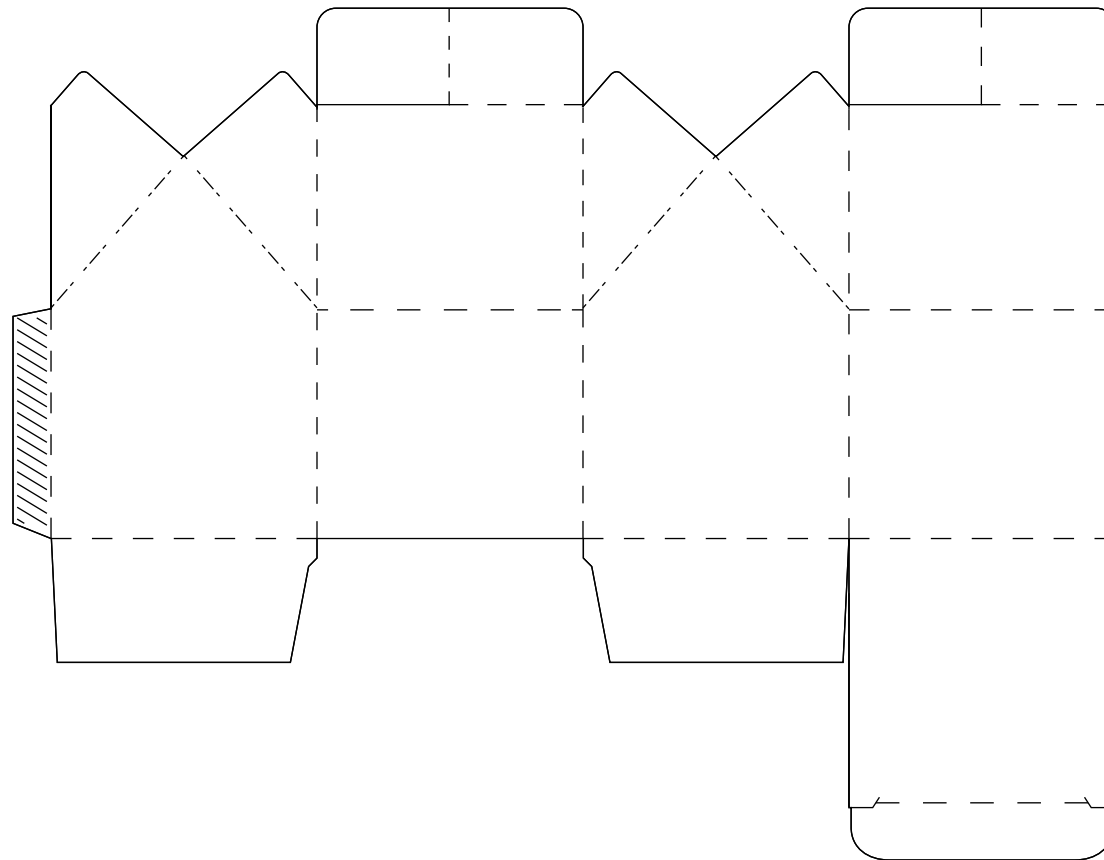

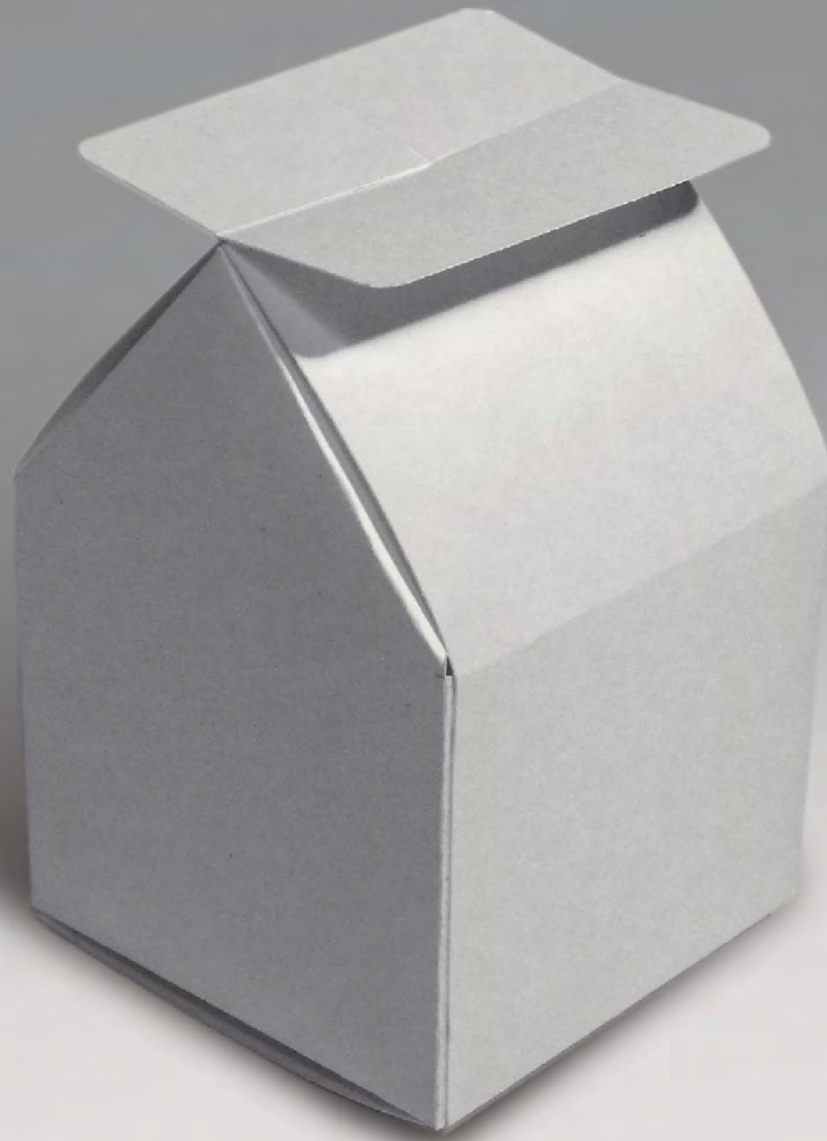

HANGING SMARTPHONE CASE BOX

The interactive presentation of this box looks beautiful hanging on a peg, but the real charm is the moving insert that holds the case in place. When the box is opened, the connected insert slides down, displaying the case vertically.

Click to See More

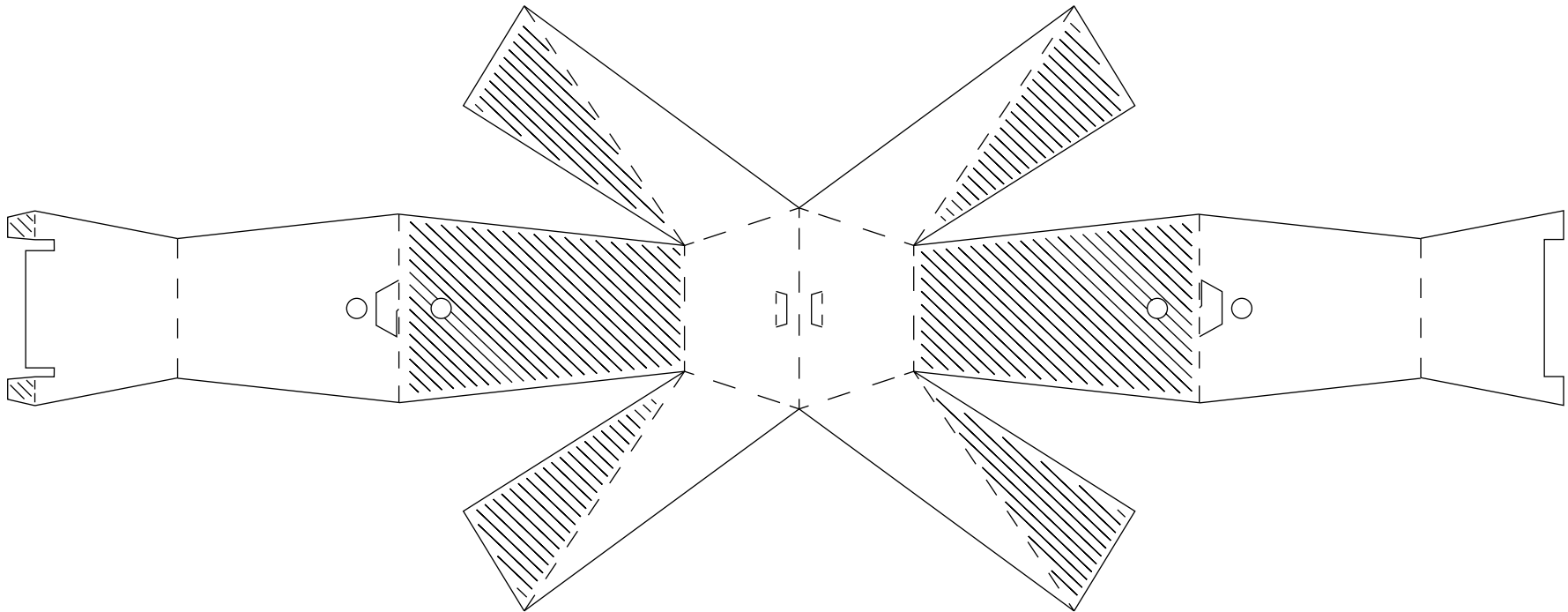

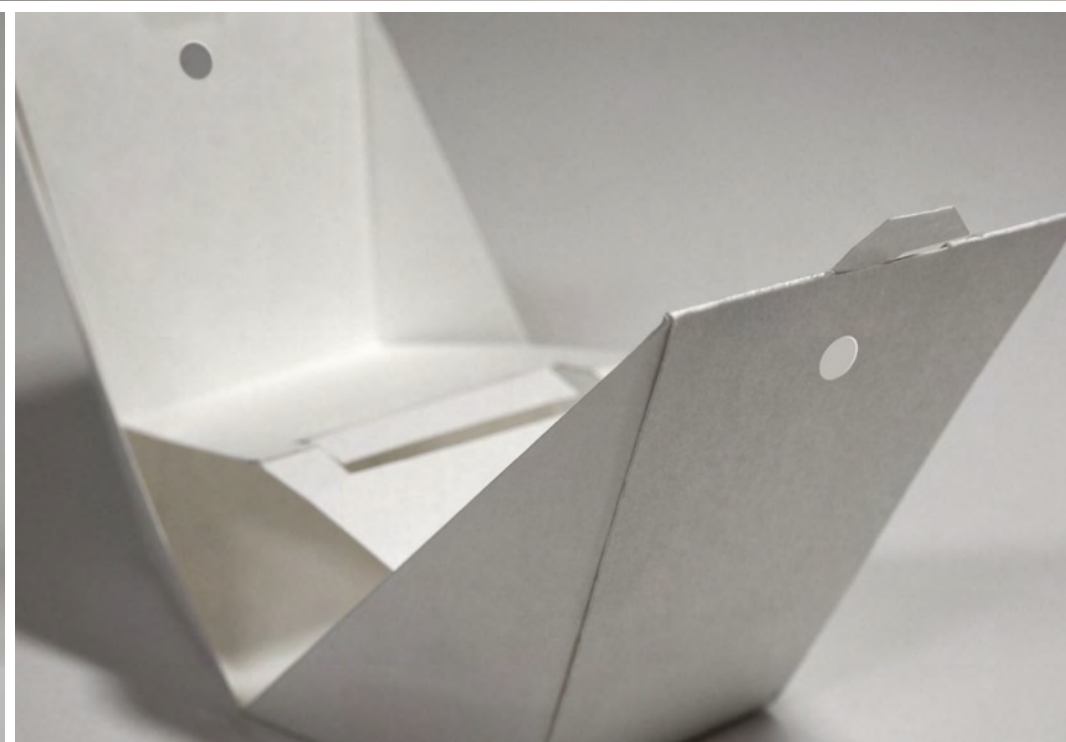
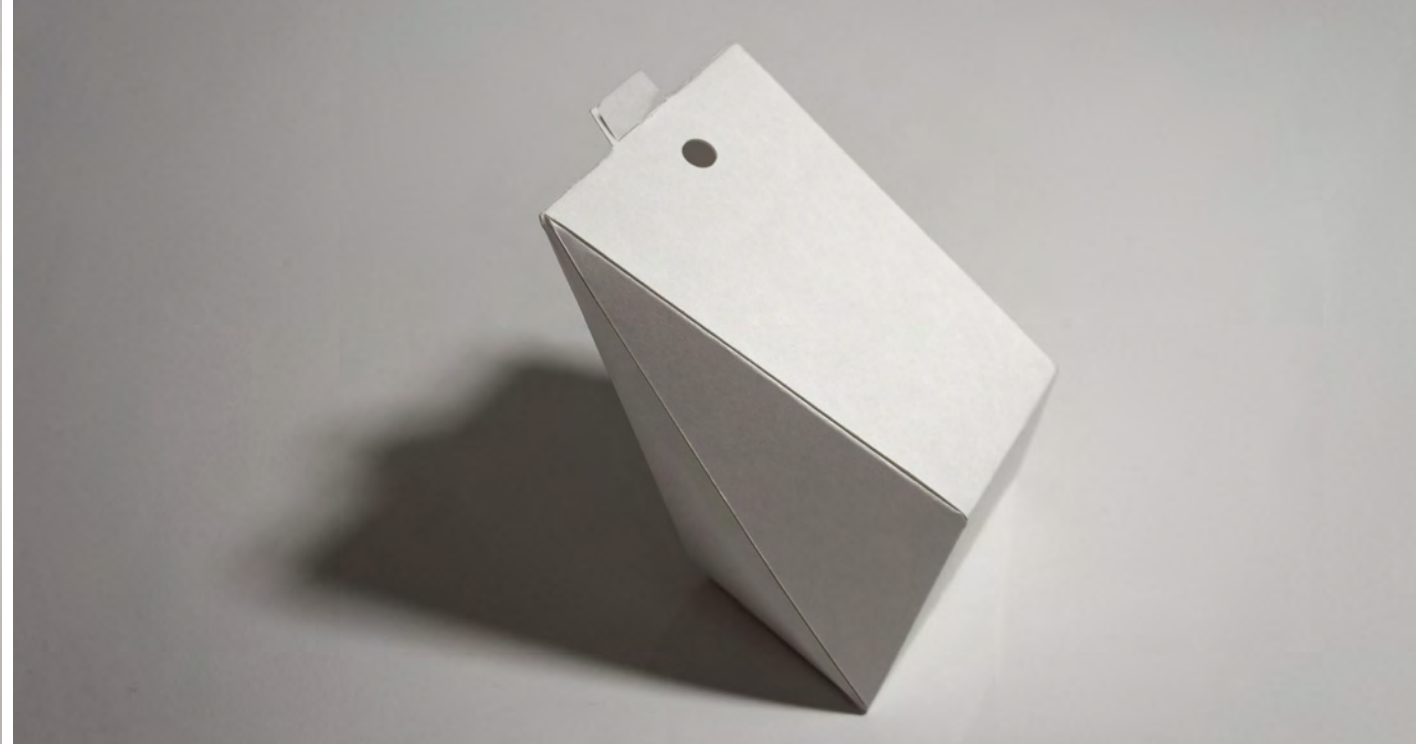

1-PIECE DOUBLE-WALL FOLDING BOX

This 1-piece box is a retail standard behind the counter. "Double wall" refers to the thickness of the lid and base as it folds in to itself for added rigidity.

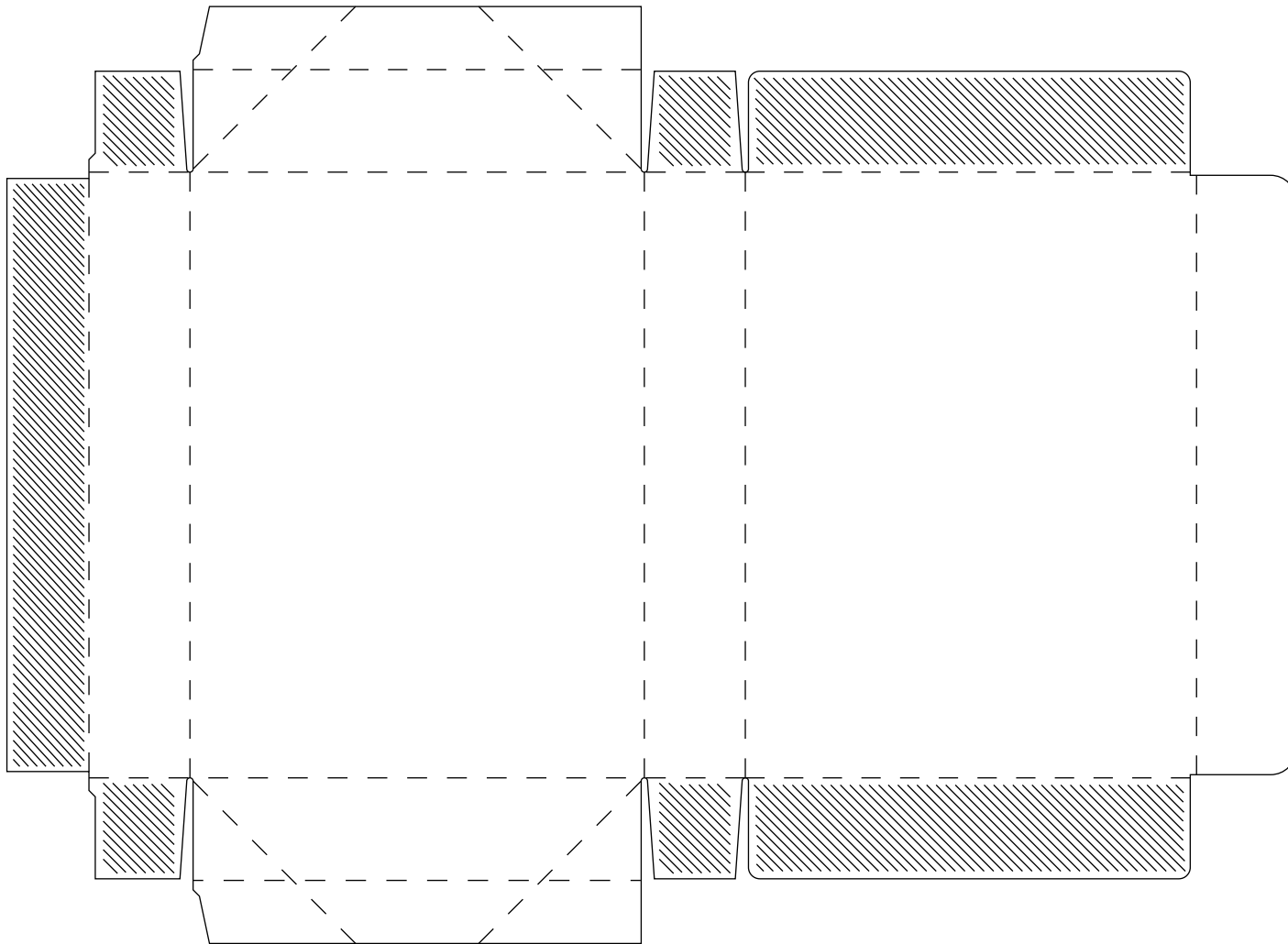

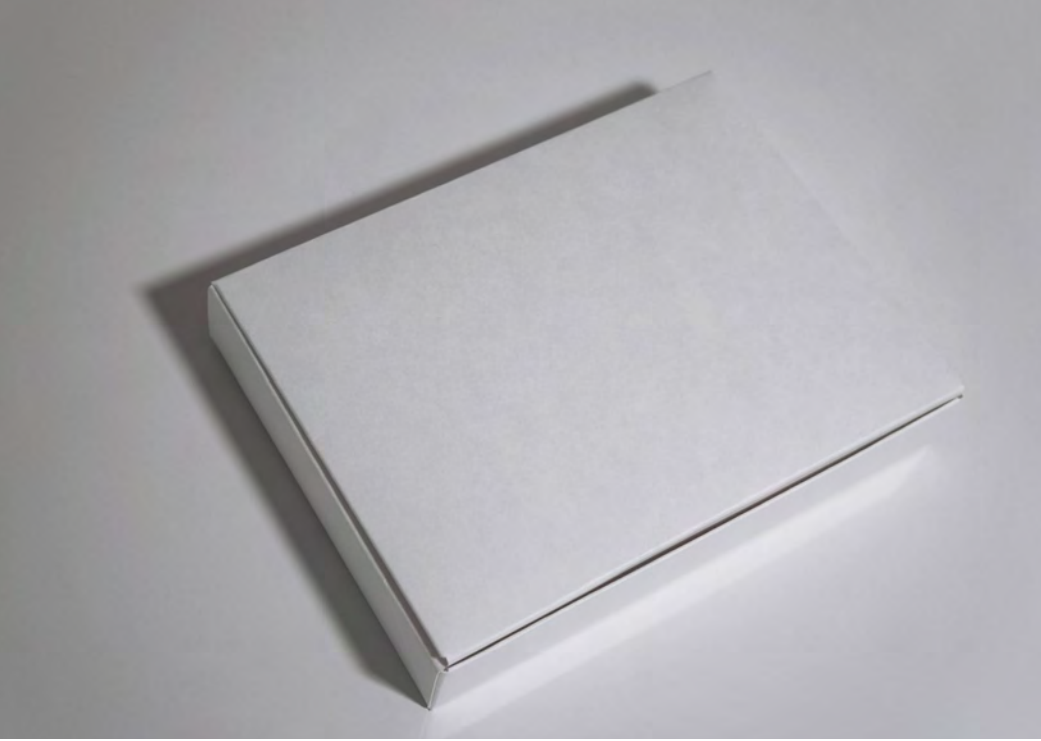

1-PIECE TUCK BOX WITH INSERT

Tuck boxes fold flat, and any inserts typically require a separate component. In this case, we have designed the insert to be part of the main structure. The box also collapses flat at an angle through a unique construction.

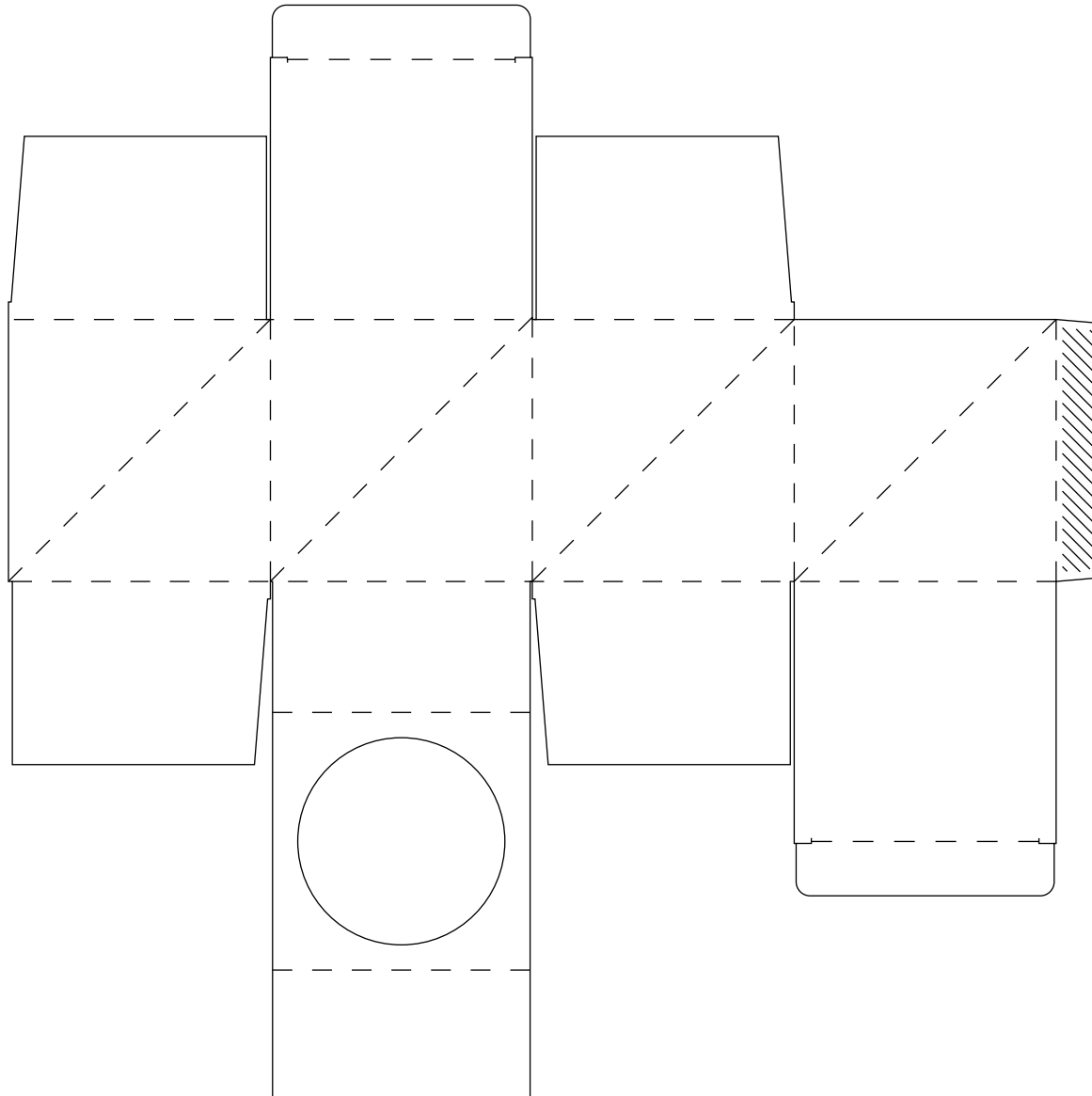

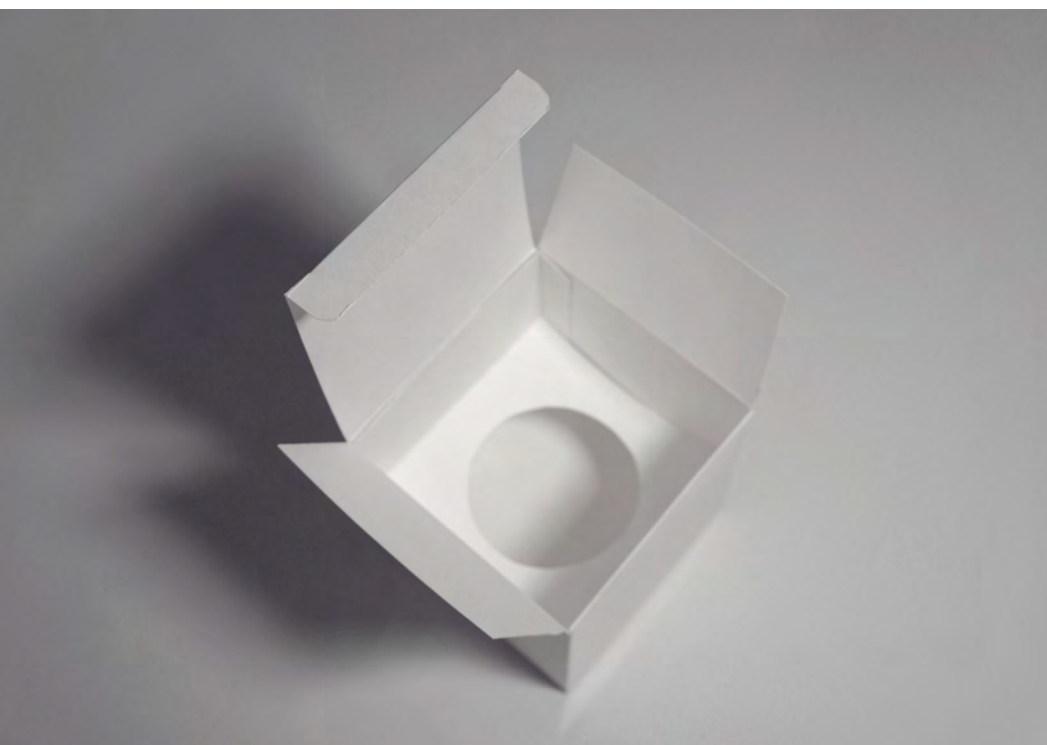
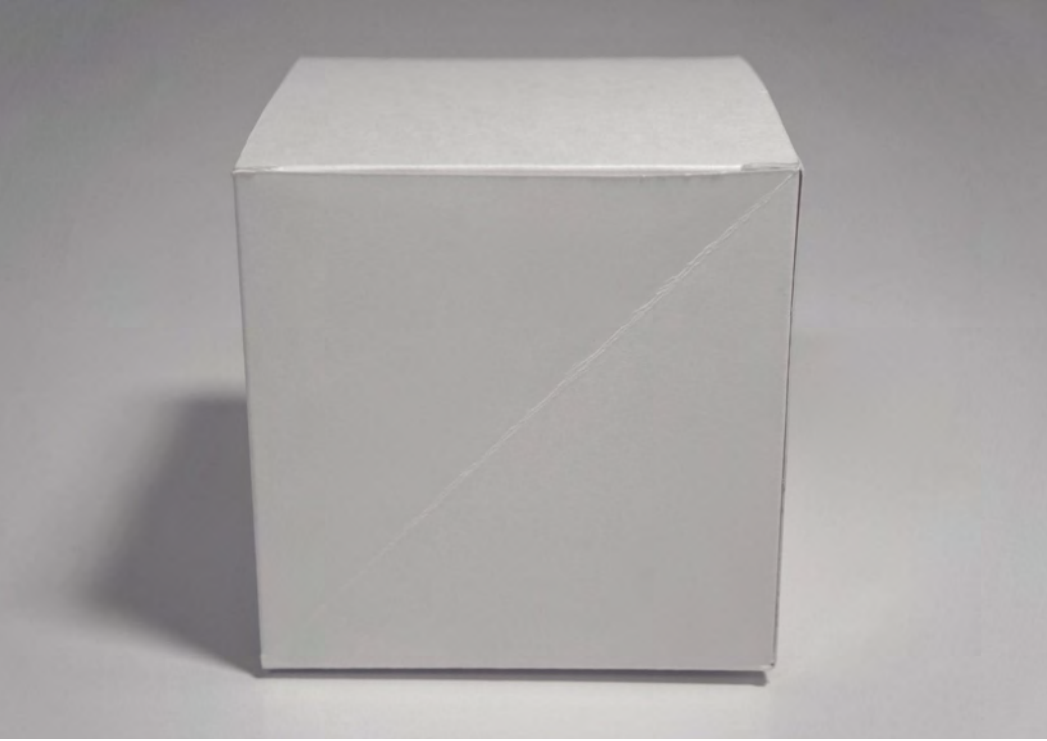

1-PIECE TUCK BOX WITH SLOTTED INSERT

Tuck boxes fold flat and typically any inserts required are a separate component. In this case, we have designed the insert to be part of the main structure. The base consists of a 1,2,3 bottom requiring no glue and assembles easily at retail.

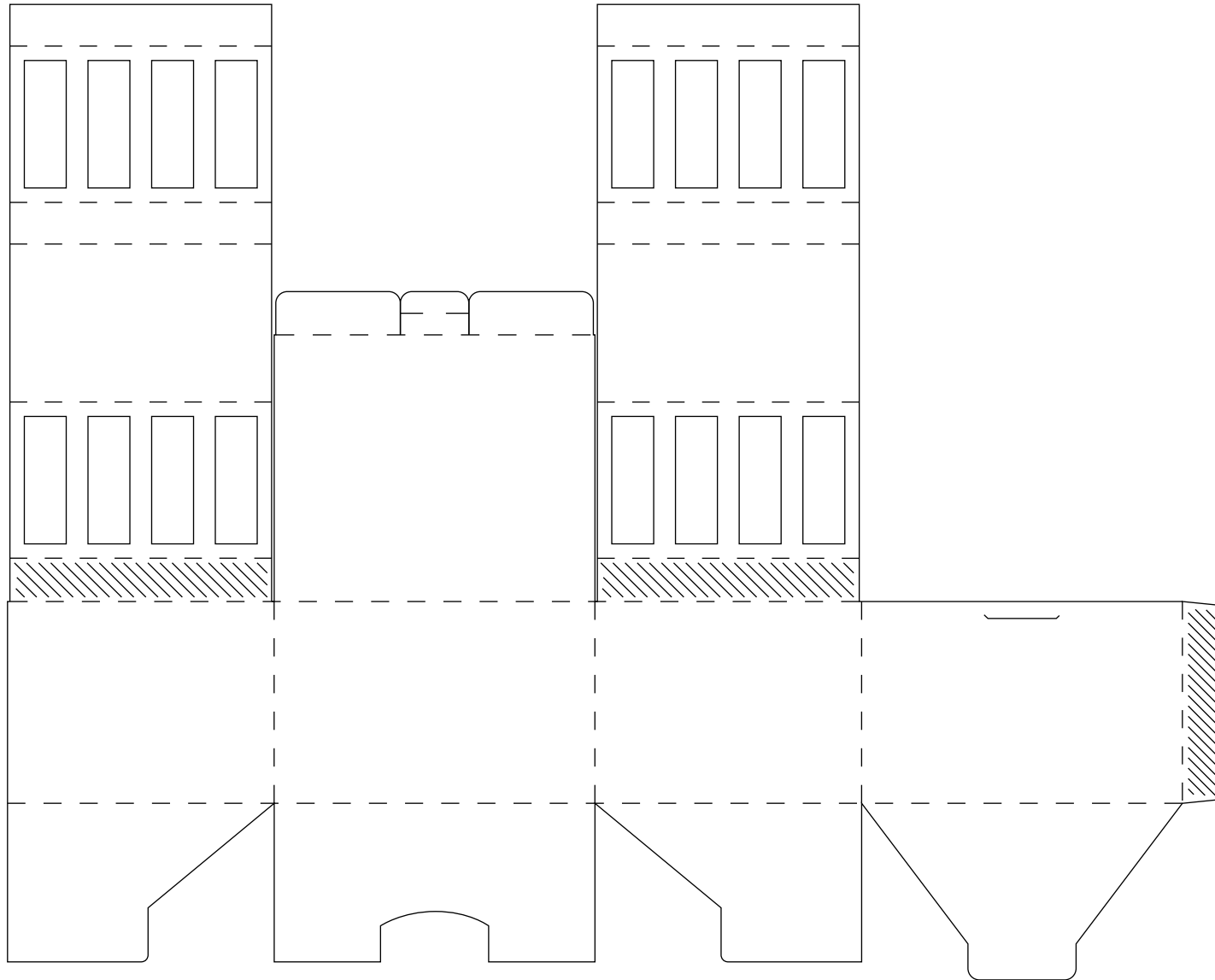



PILLOW BOX

The pillow box is a standard container that remains flat until the side flaps are closed, which creates the convex pillow structure this construction is known for.

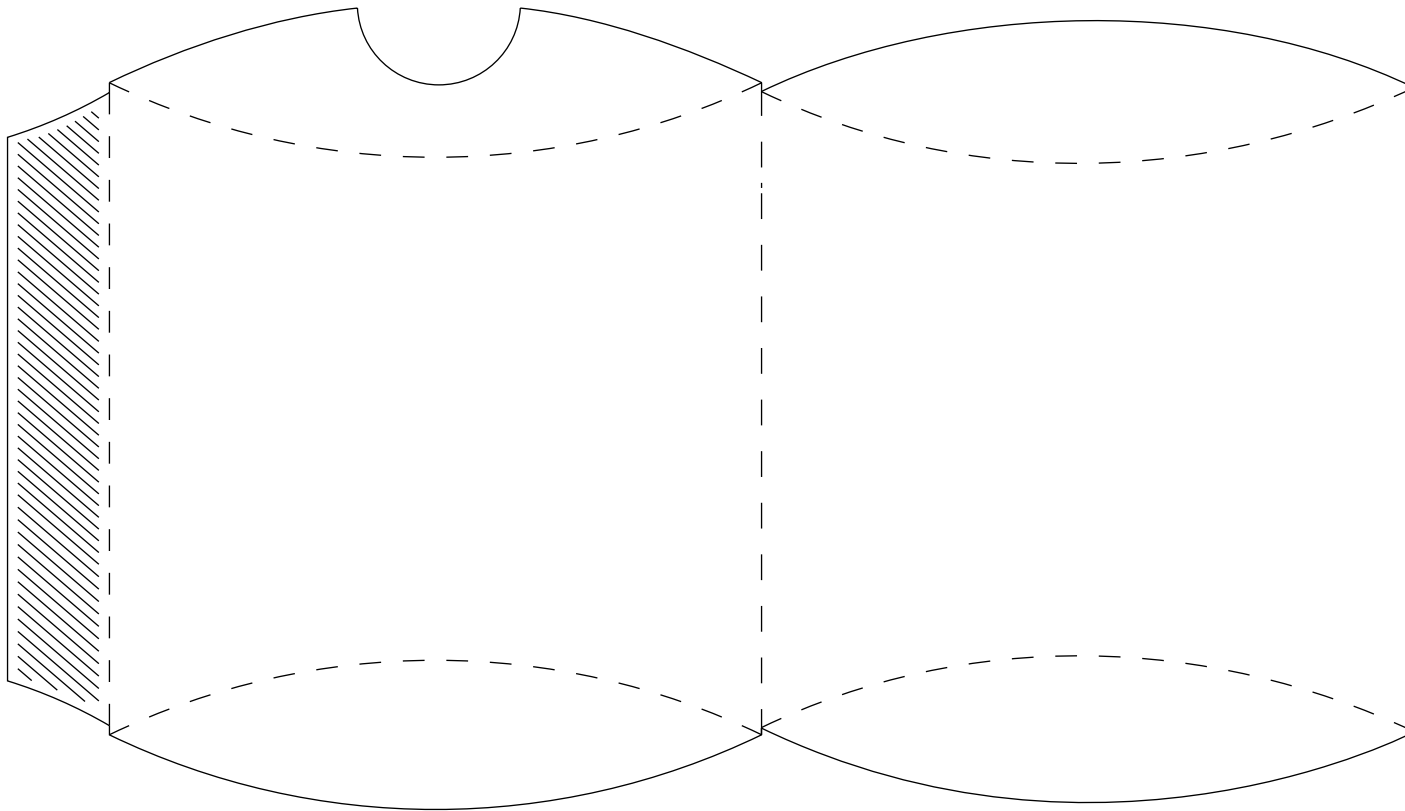

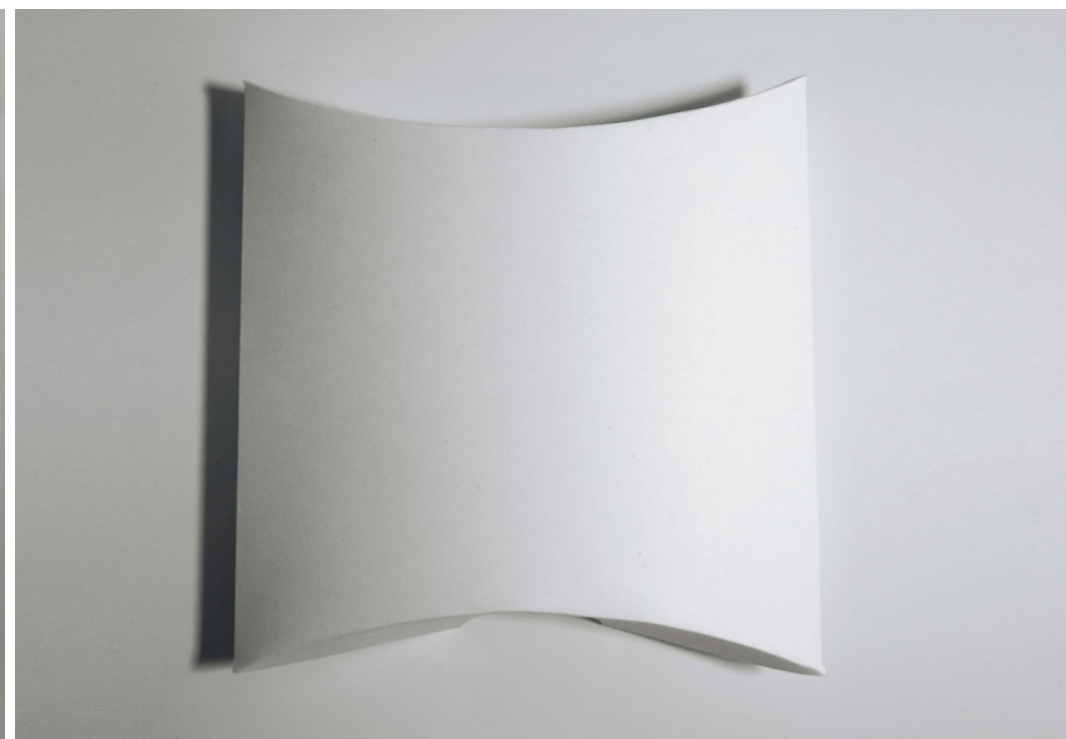
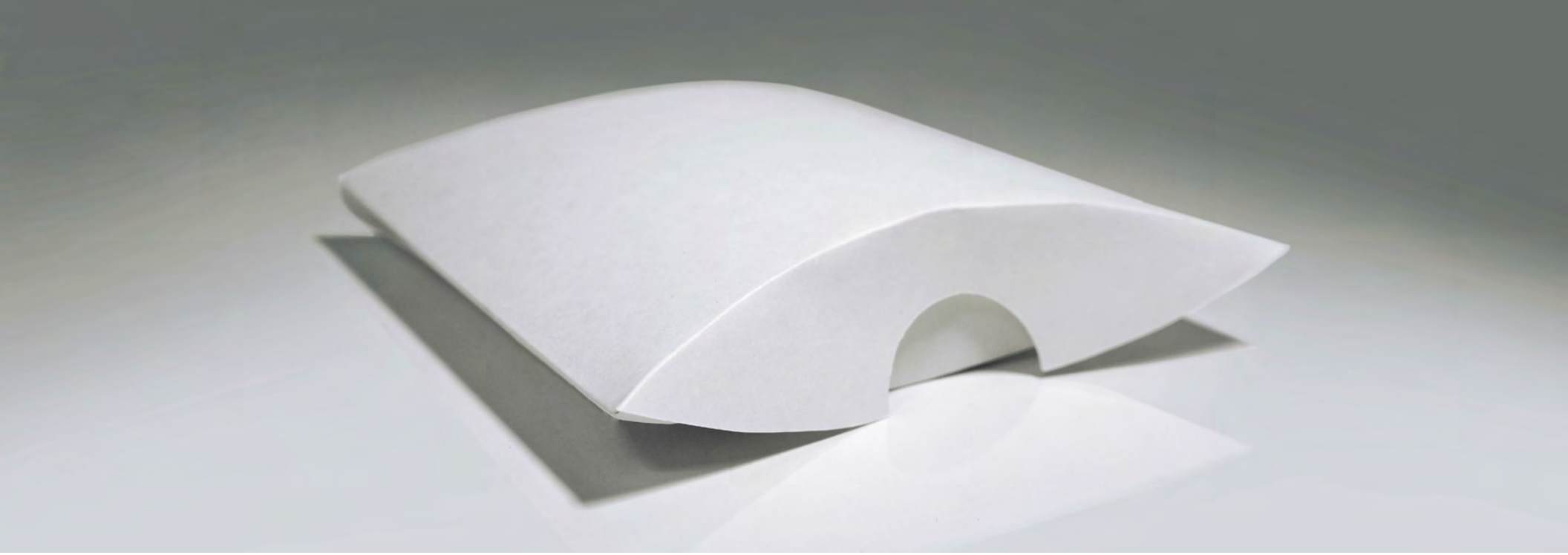

POINTED CAP BOX

An exploration in folds and closures, this box provides a large angled billboard area that breaks up the monotony of the retail shelf.

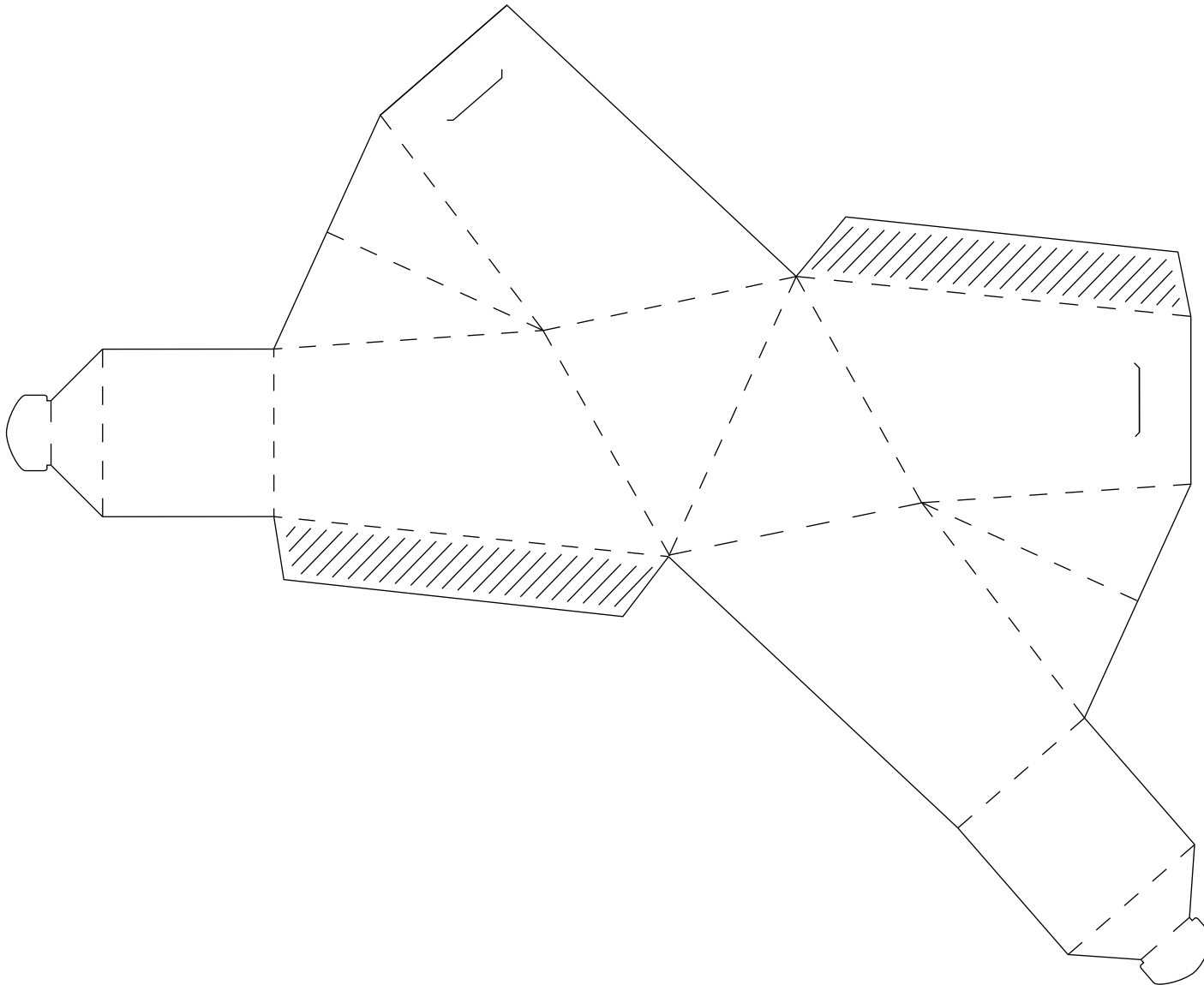

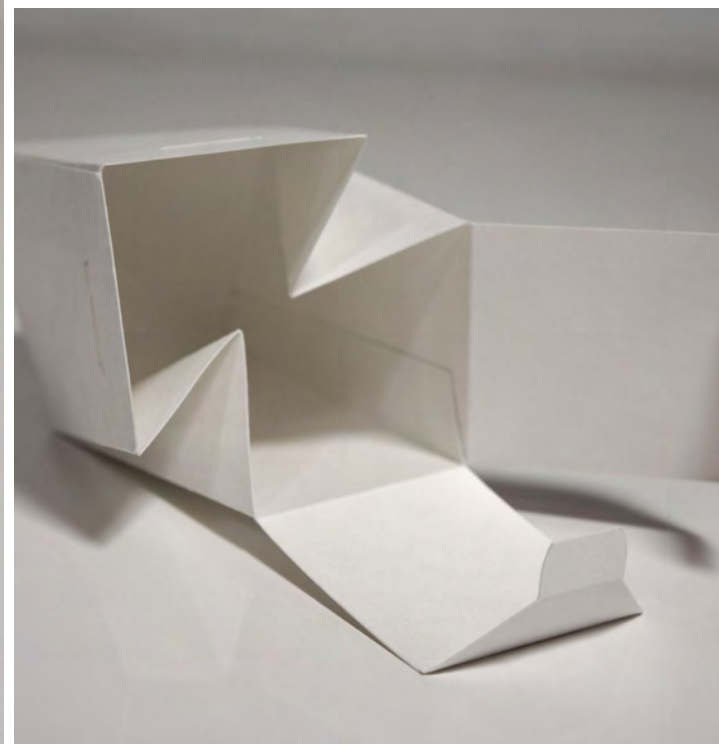
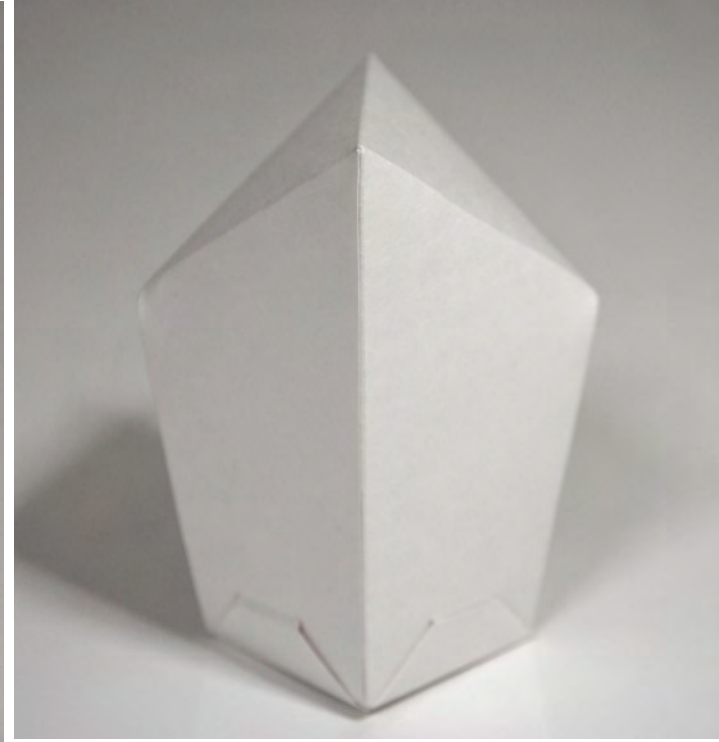
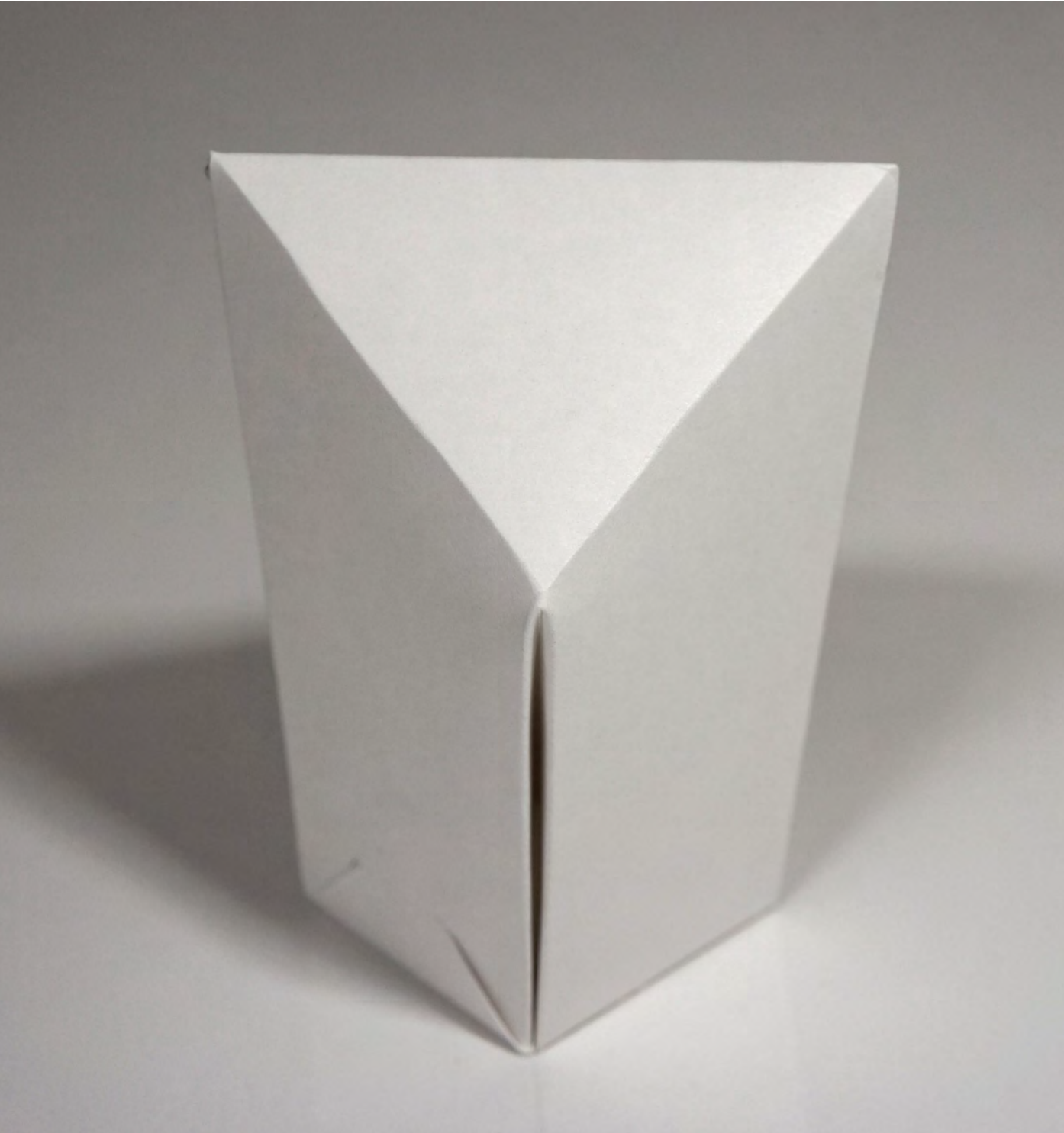

POLYGONAL BOX

This study in geometric shapes is able to be stored flat, and pop open quickly for ease of use. The multi-faceted panels create a beautiful interplay with light and shadows making this little concept a keepsake.

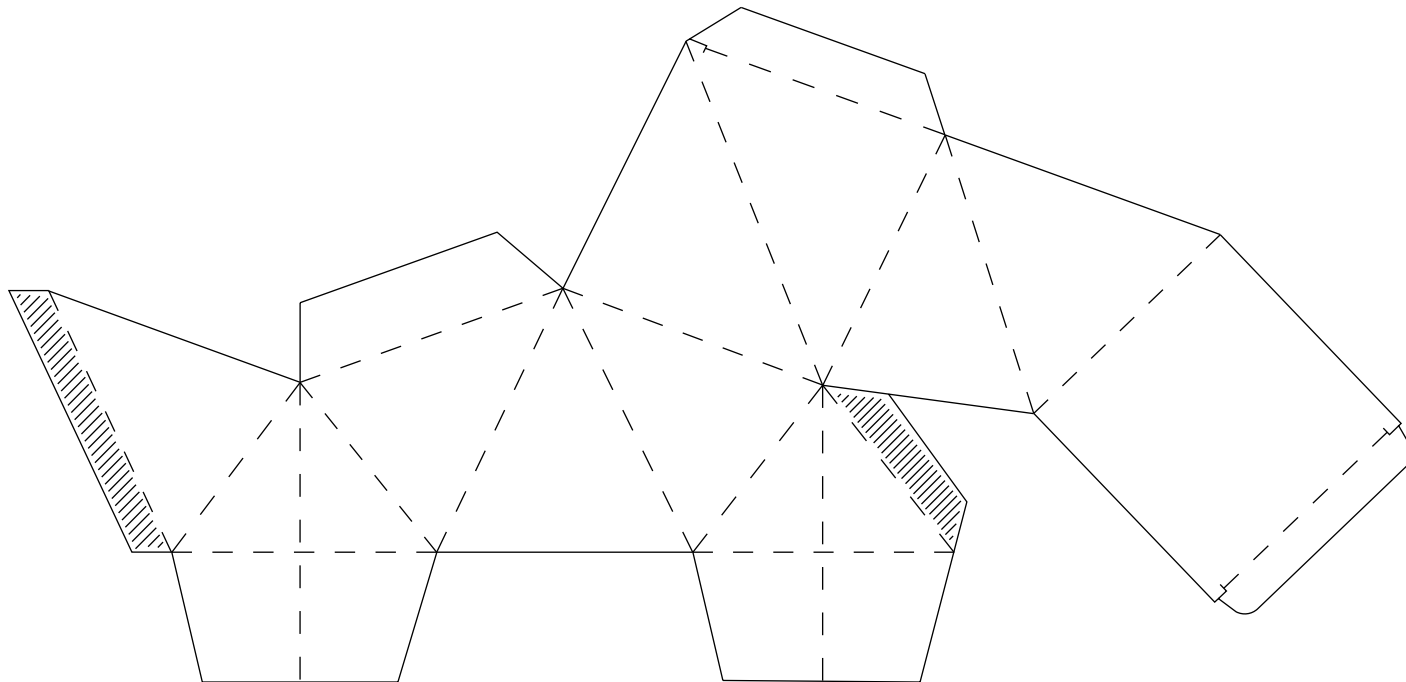

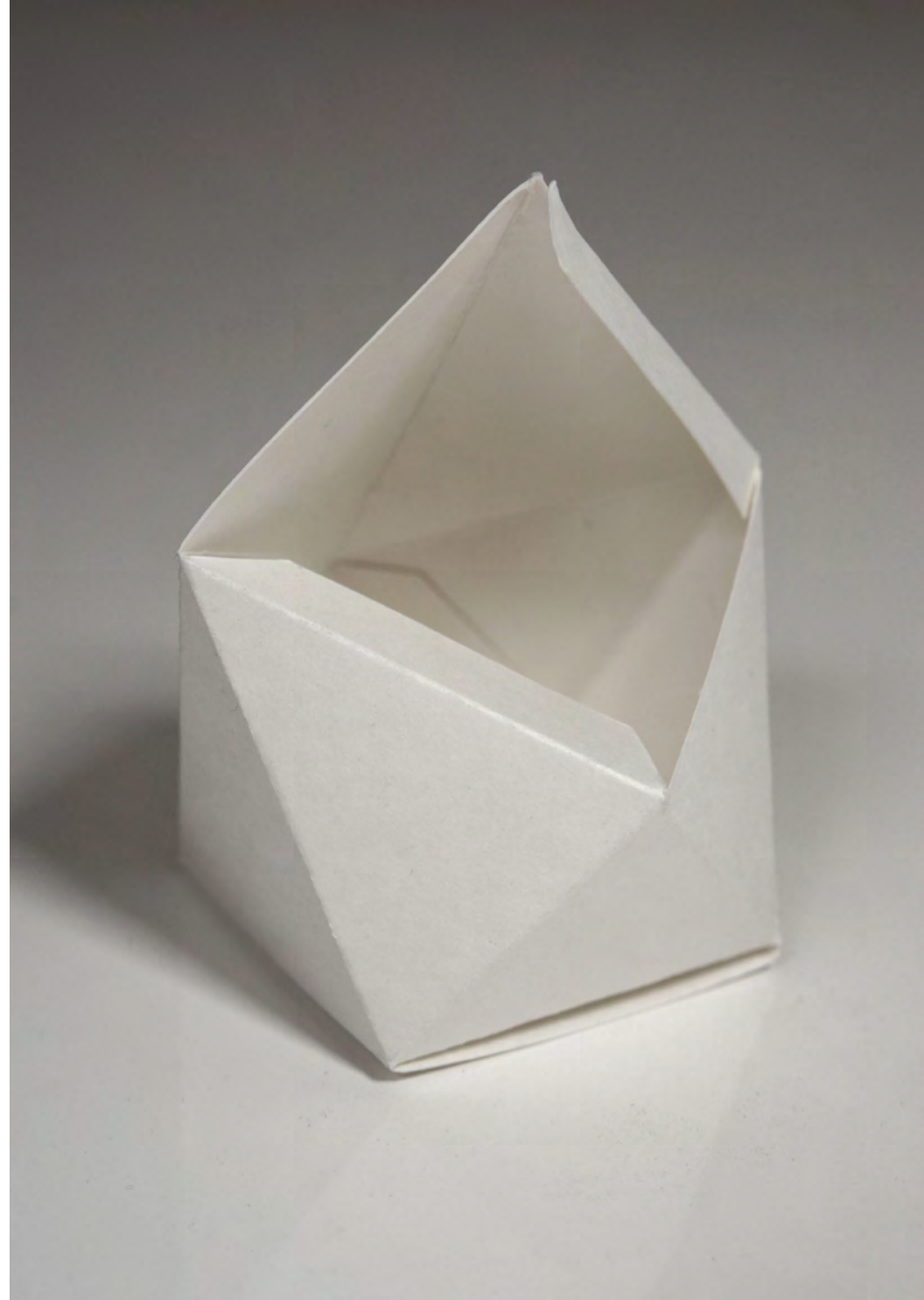

PYRAMID BOX

The Pyramid Box sits solidly in place, held together by an elastic band. The box then blossoms open to reveal the product once the elastic is removed.

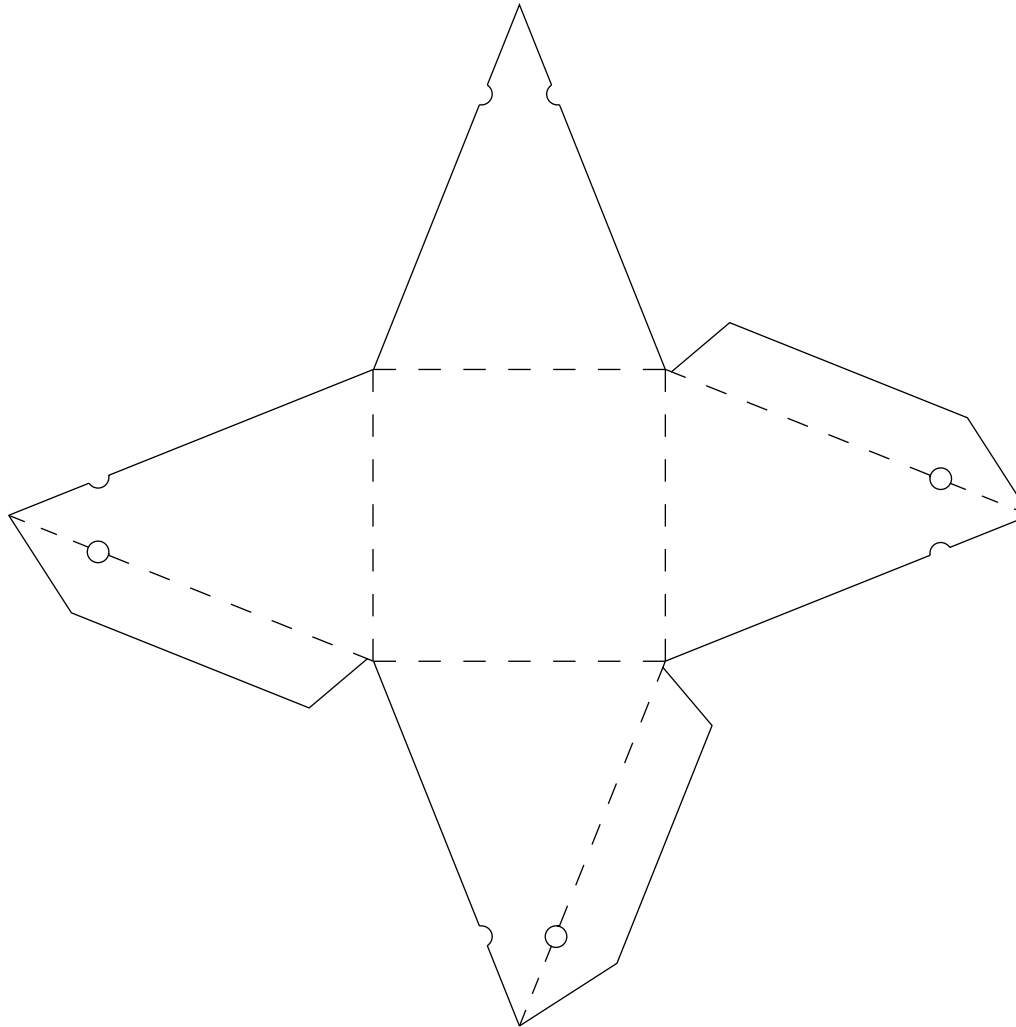



PYRAMID TOP BOX

A variation of the Pyramid Box (previous page), this box provides a vertical presentation that is held together by a threaded satin ribbon that is then tied in to a bow. It's able to open and close with ease for fulfillment and unboxing.

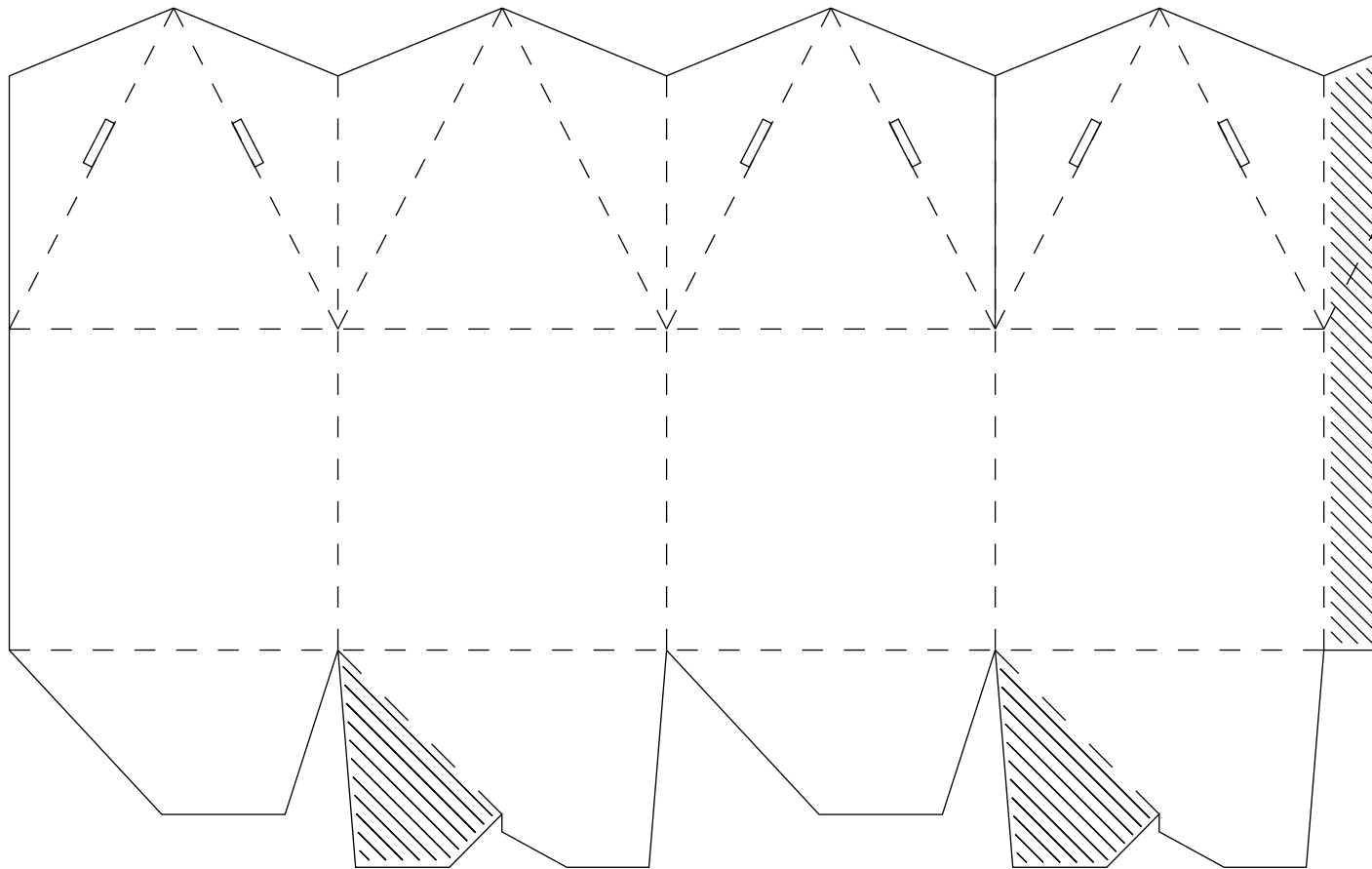



LONG BOX

The Long Box has two drawbridge-like doors that swing open to reveal the contents inside the box. Perfect for pastries or apparel (though not together), this box is glue-less, and versatile enough to accommodate a variety of products.

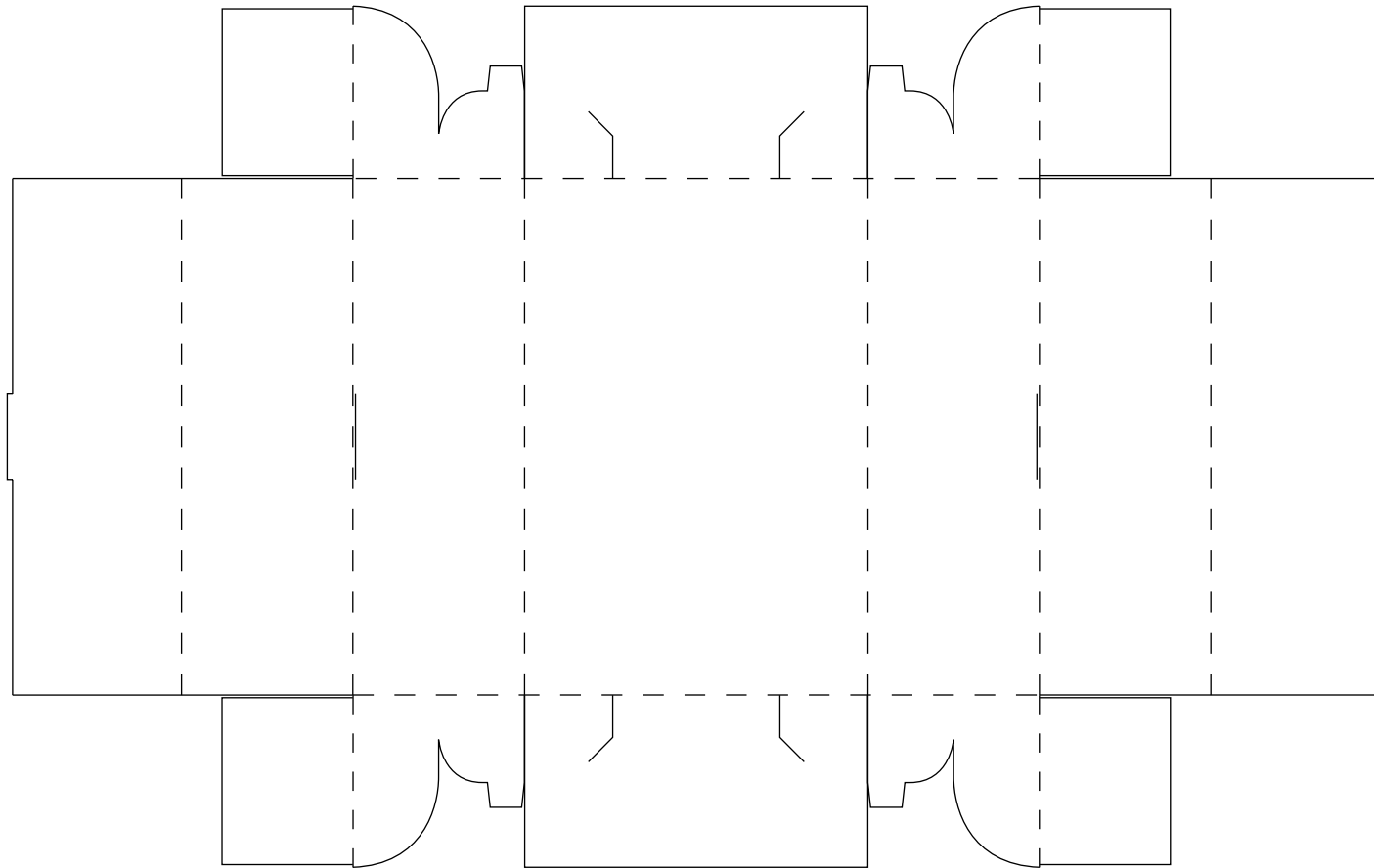



TRIANGULAR BOX

The Triangular Box features an inverted diamond-like construction that secures in place with a locking tab. The glued fold-over flaps add rigidity and a finished edge.

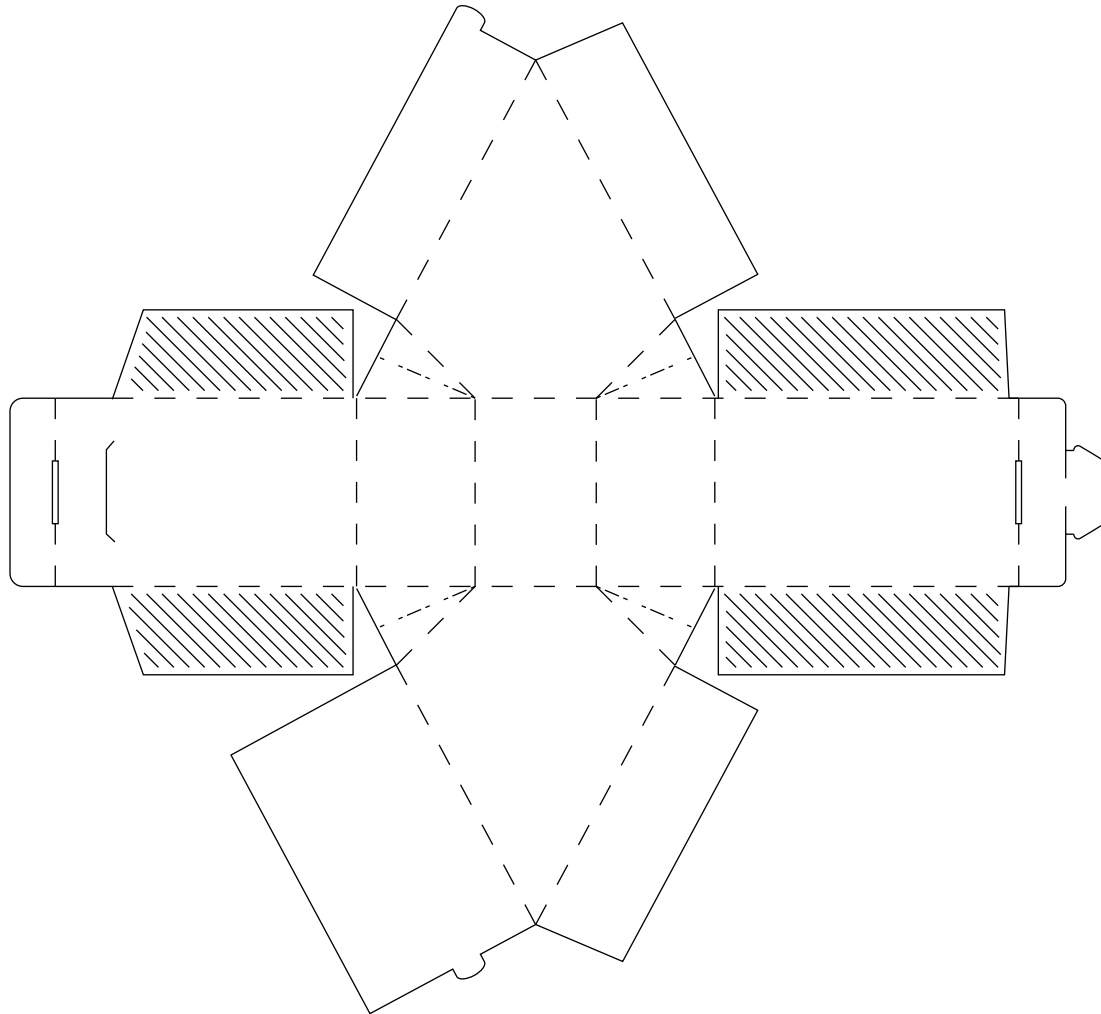

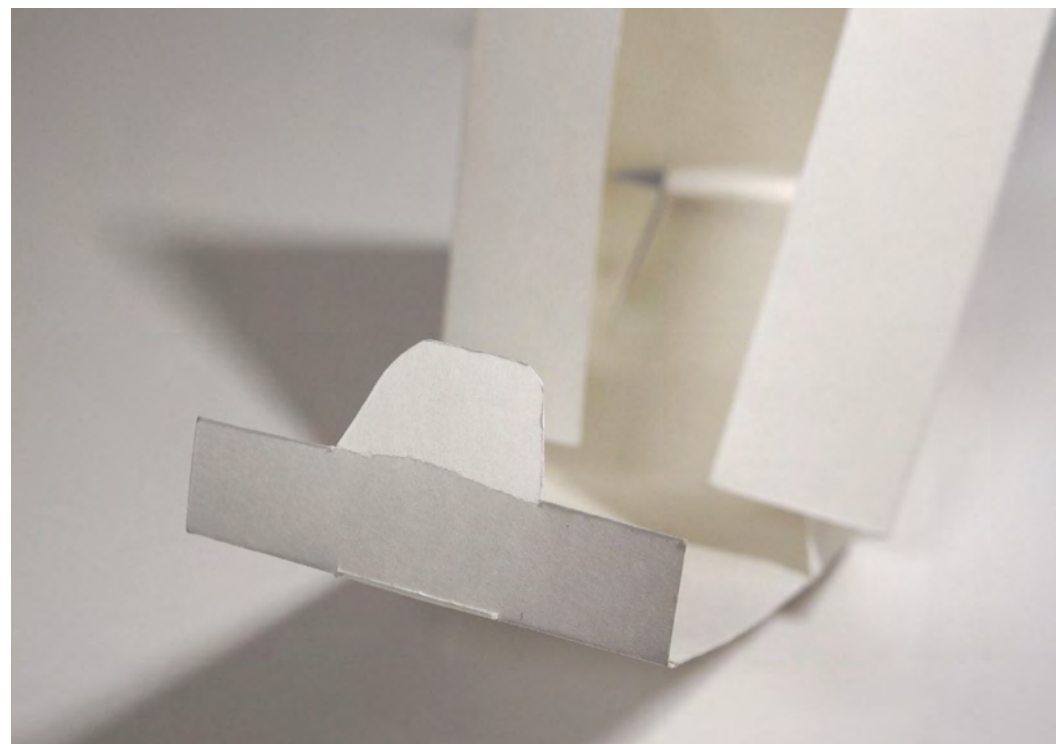
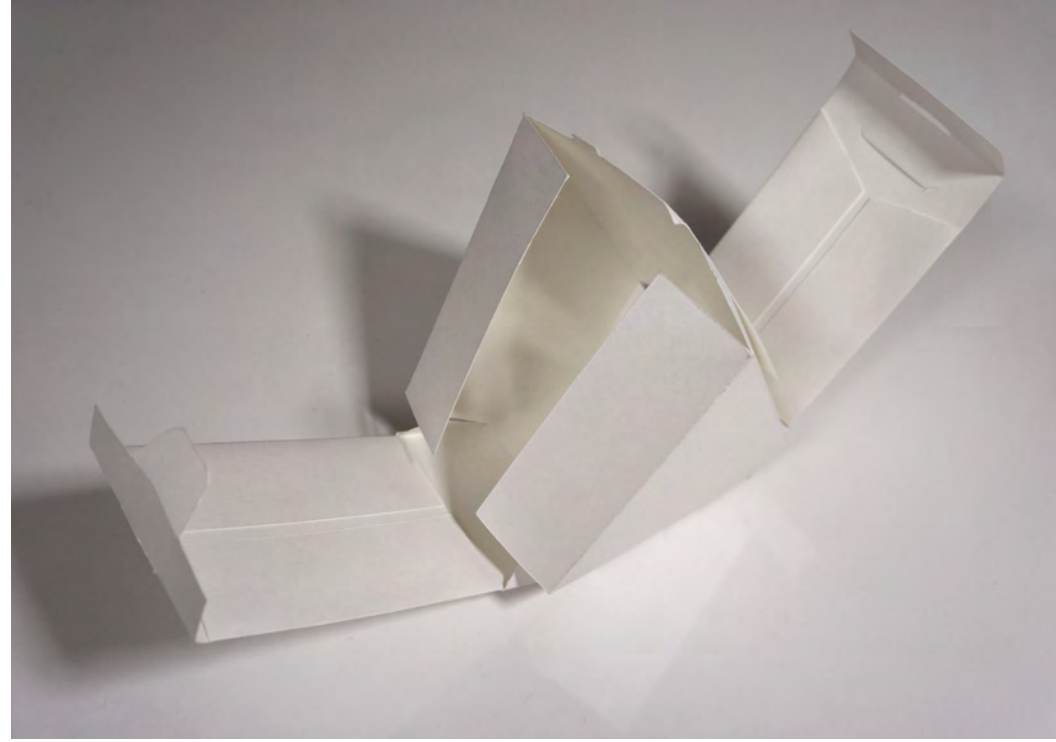

THREADED 2-PIECE FOLDING BOX

This ultra-interactive, threaded two-piece box squeezes to half its height using a bellows-like action. The lid utilizes a twisting, threaded action to separate it from its octagonal base.

Click to See More

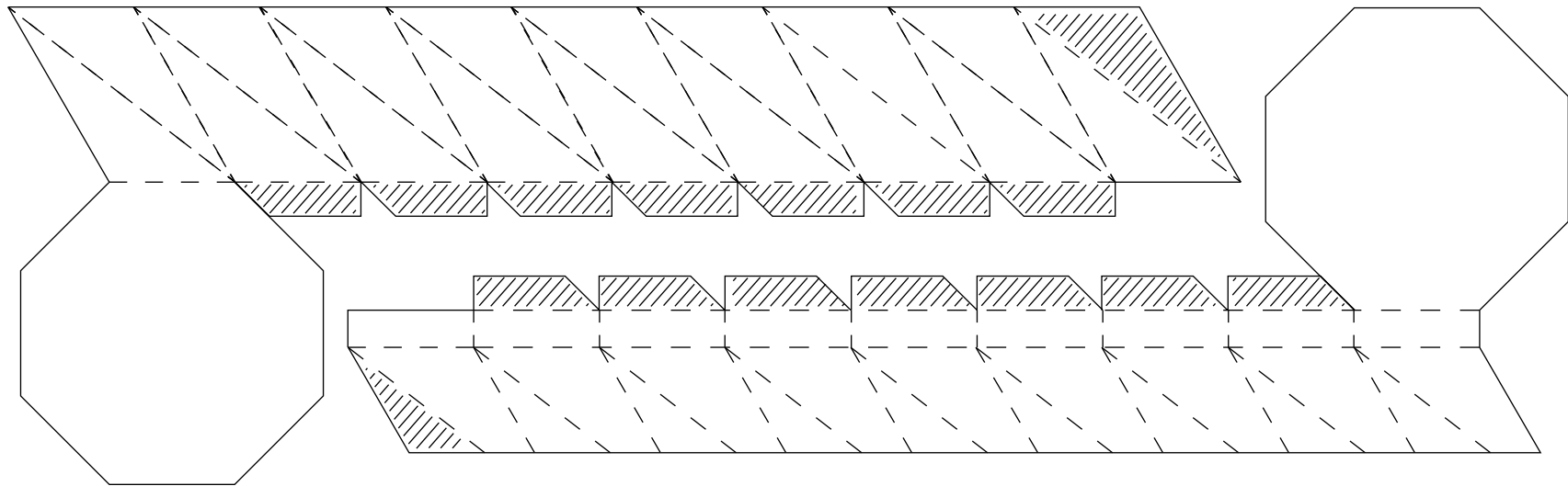

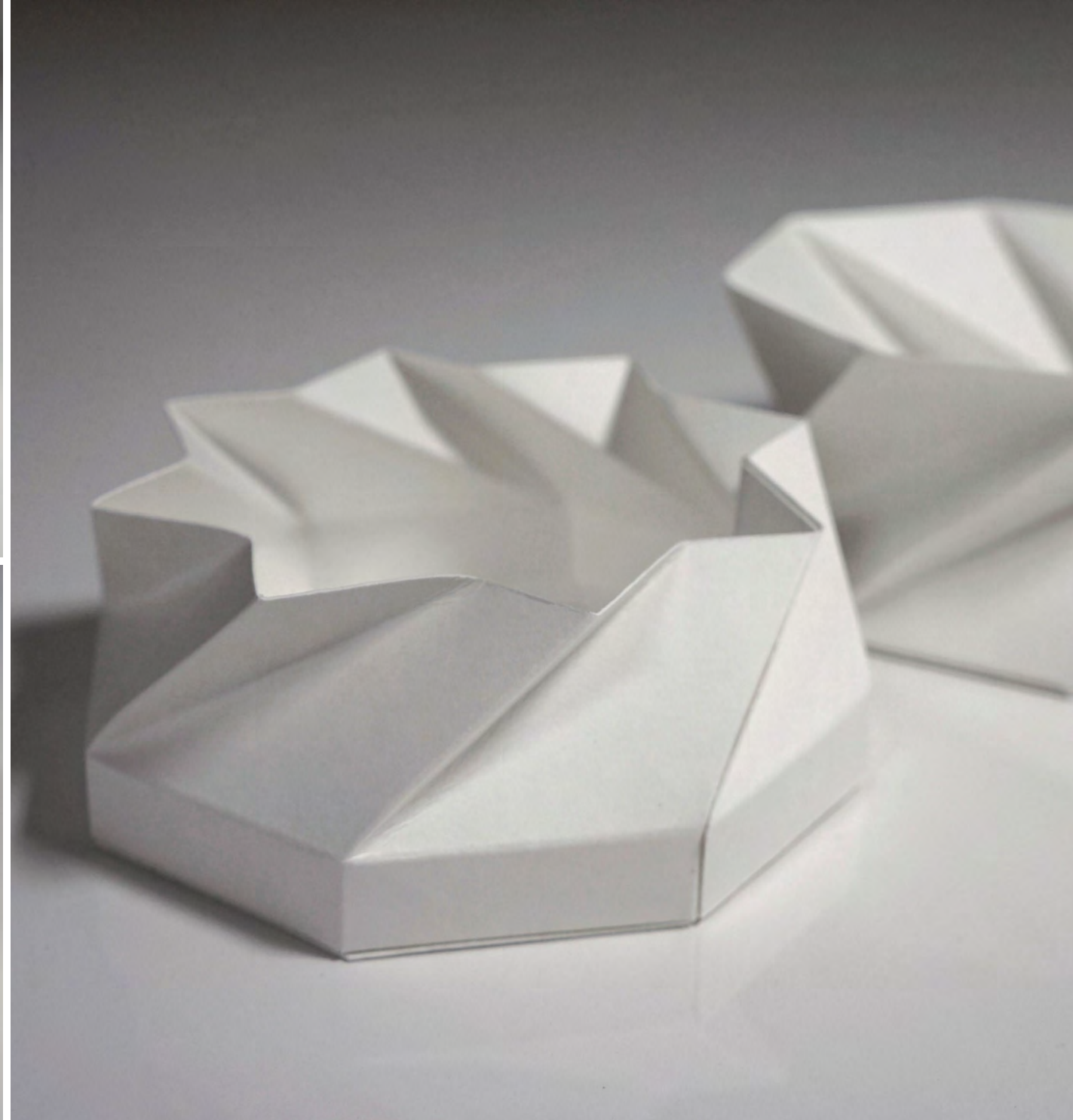

FACETED DIAMOND BOX

The Faceted Diamond Box is a simple structure that will require a closure mechanism consisting of either a decal, a ribbon tie, or cherry-locks on each flap to keep it secured.

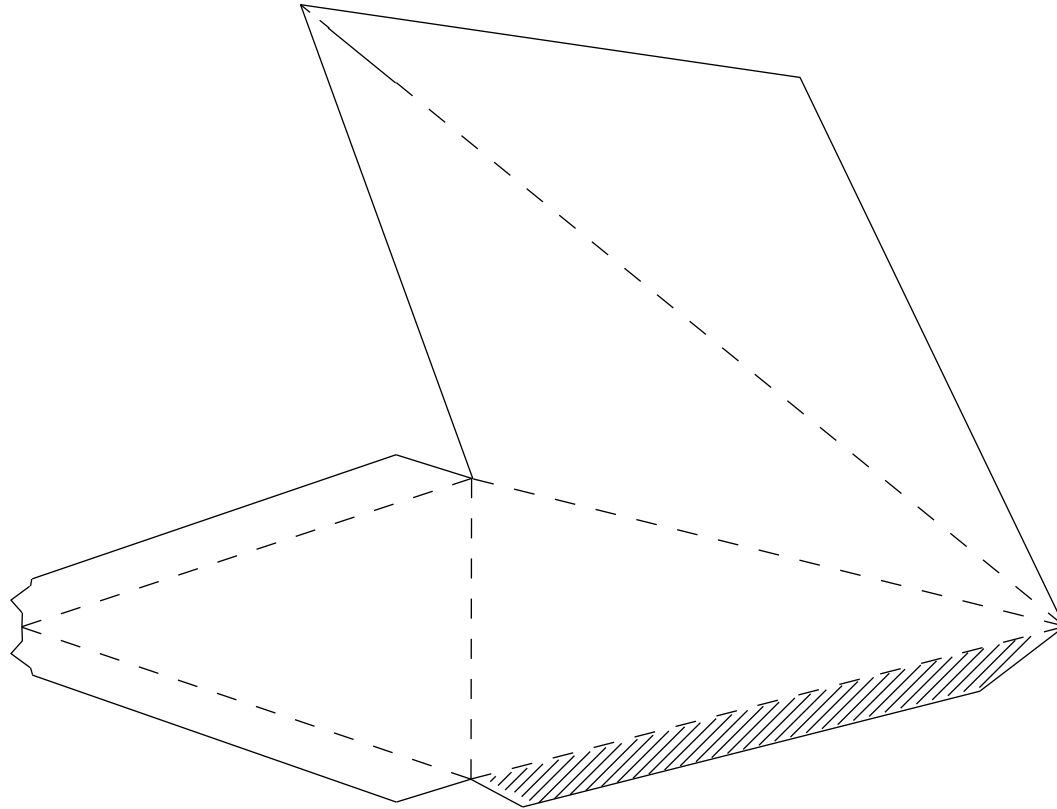

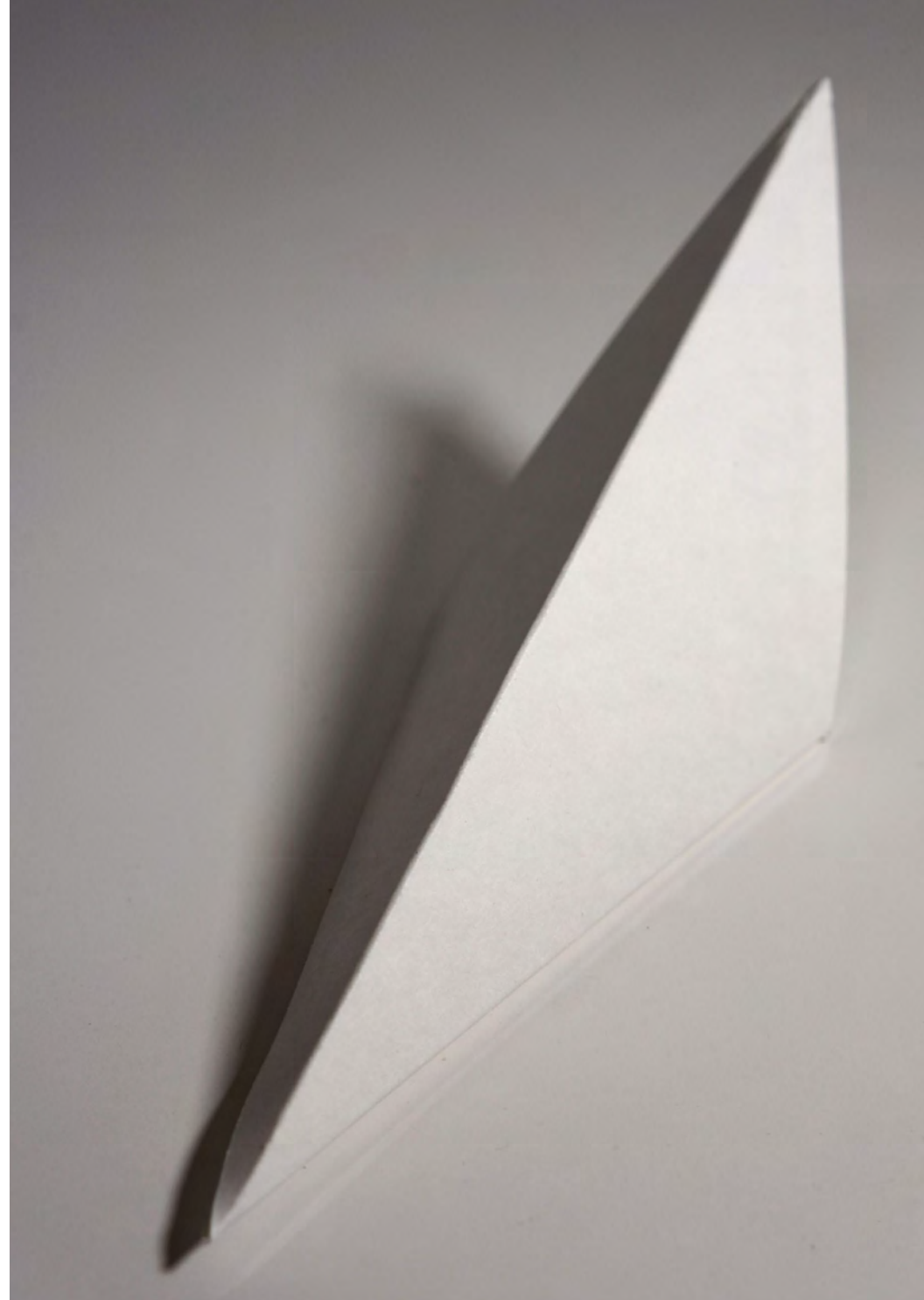
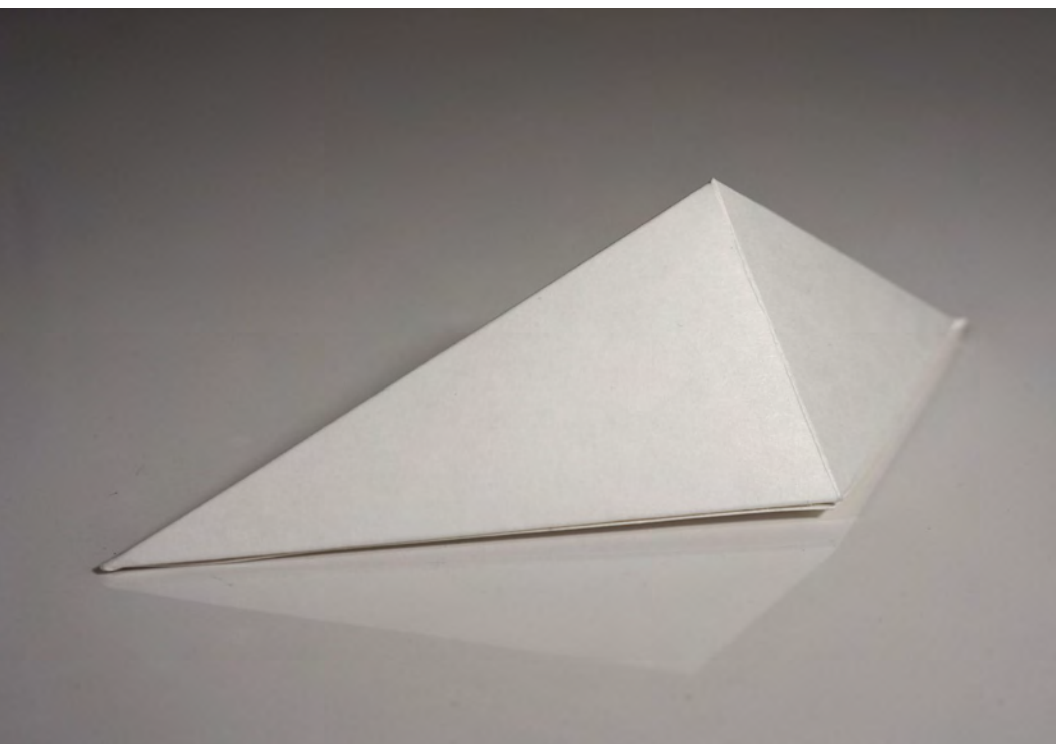
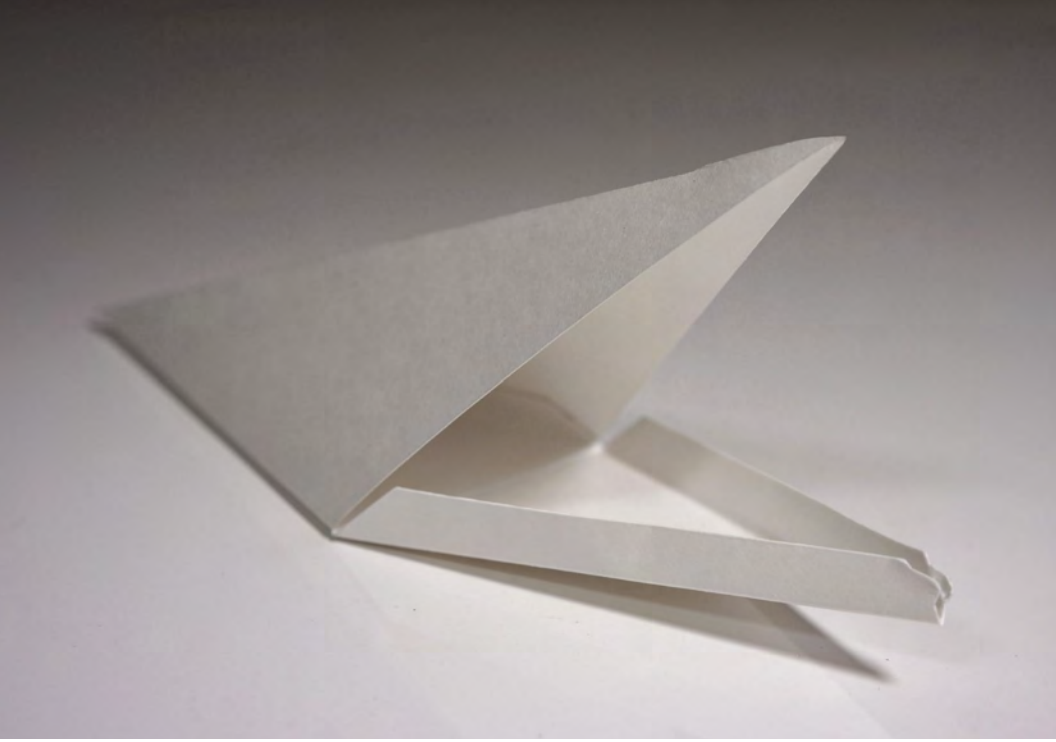

TWIST TOP GIFT BOX

The Twist Top Gift Box is a perfect way to present a bottle of wine complete with a dramatic twist-top closure. This box accessorizes beautifully with a wide ribbon tied around the neck of the closure and nestled in the middle die cut.

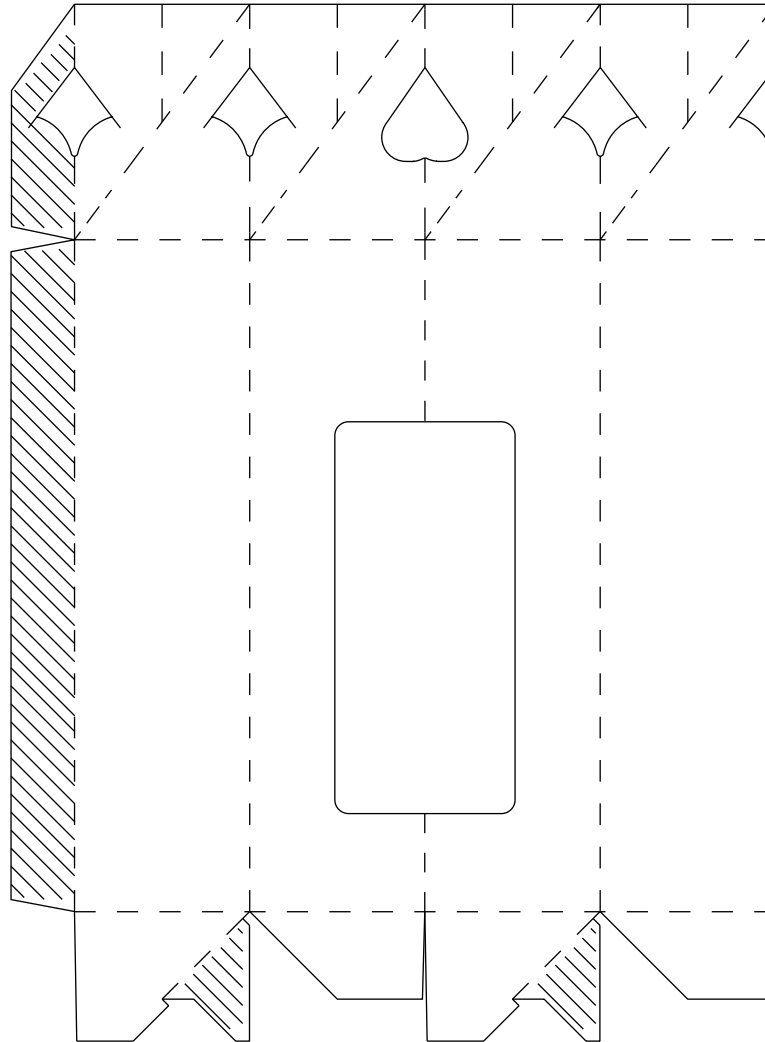



BOTTLE CARRIER

This bottle carrier concept is a simple structure that works best utilizing a micro-flute corrugate for strength as a stand-alone element, or in conjunction with a telescoping lid. The chevron diecuts allow a peek inside while the top can be used as a handle.

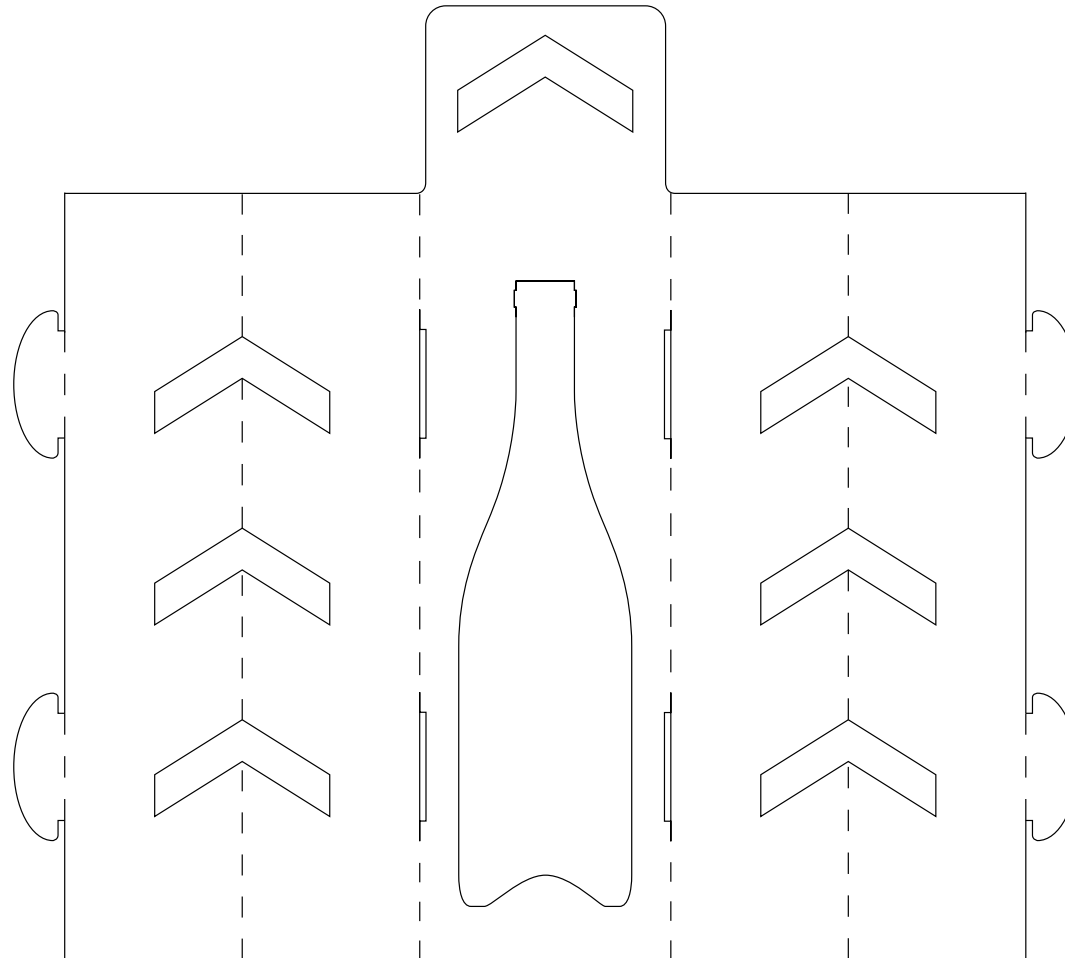

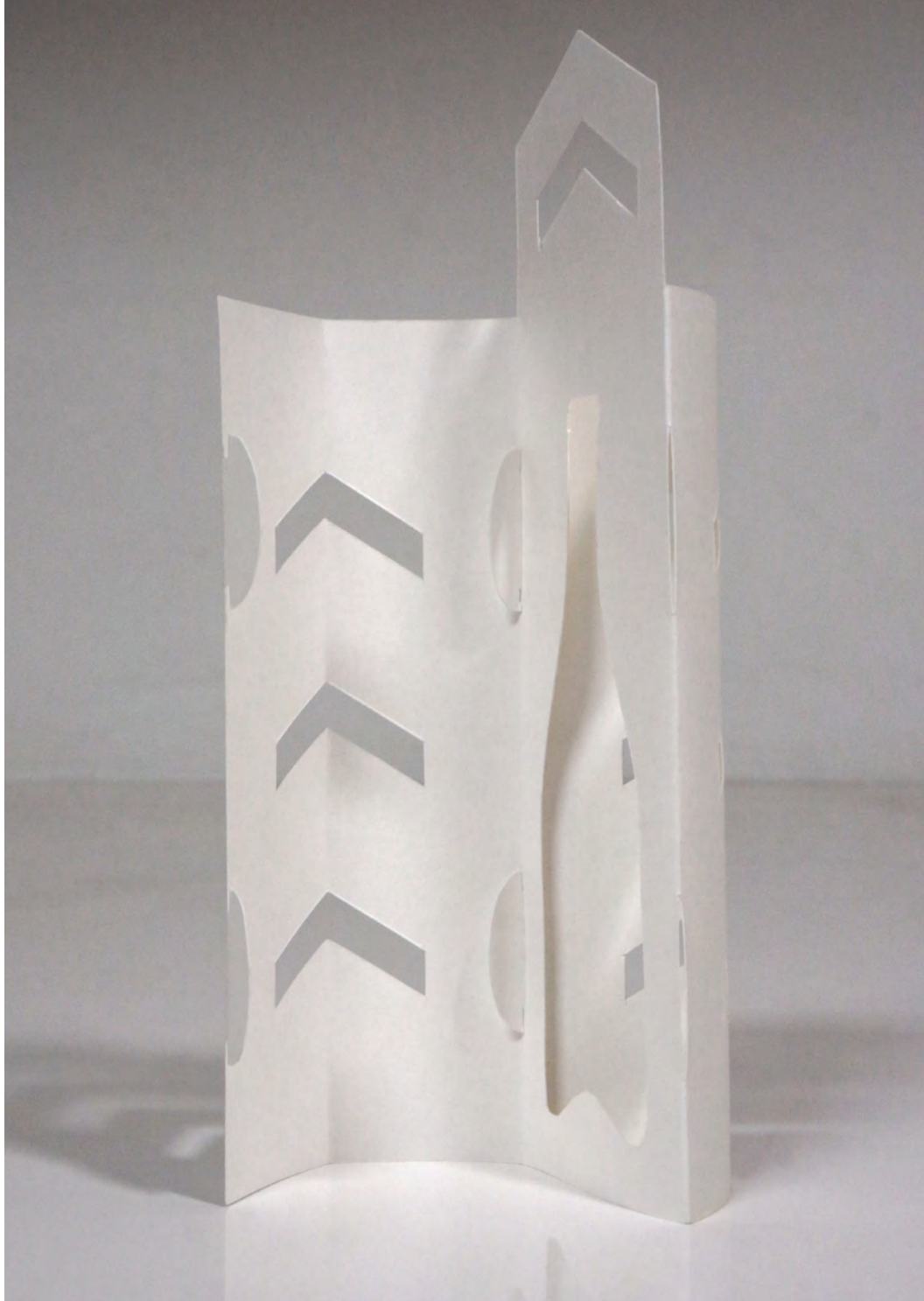
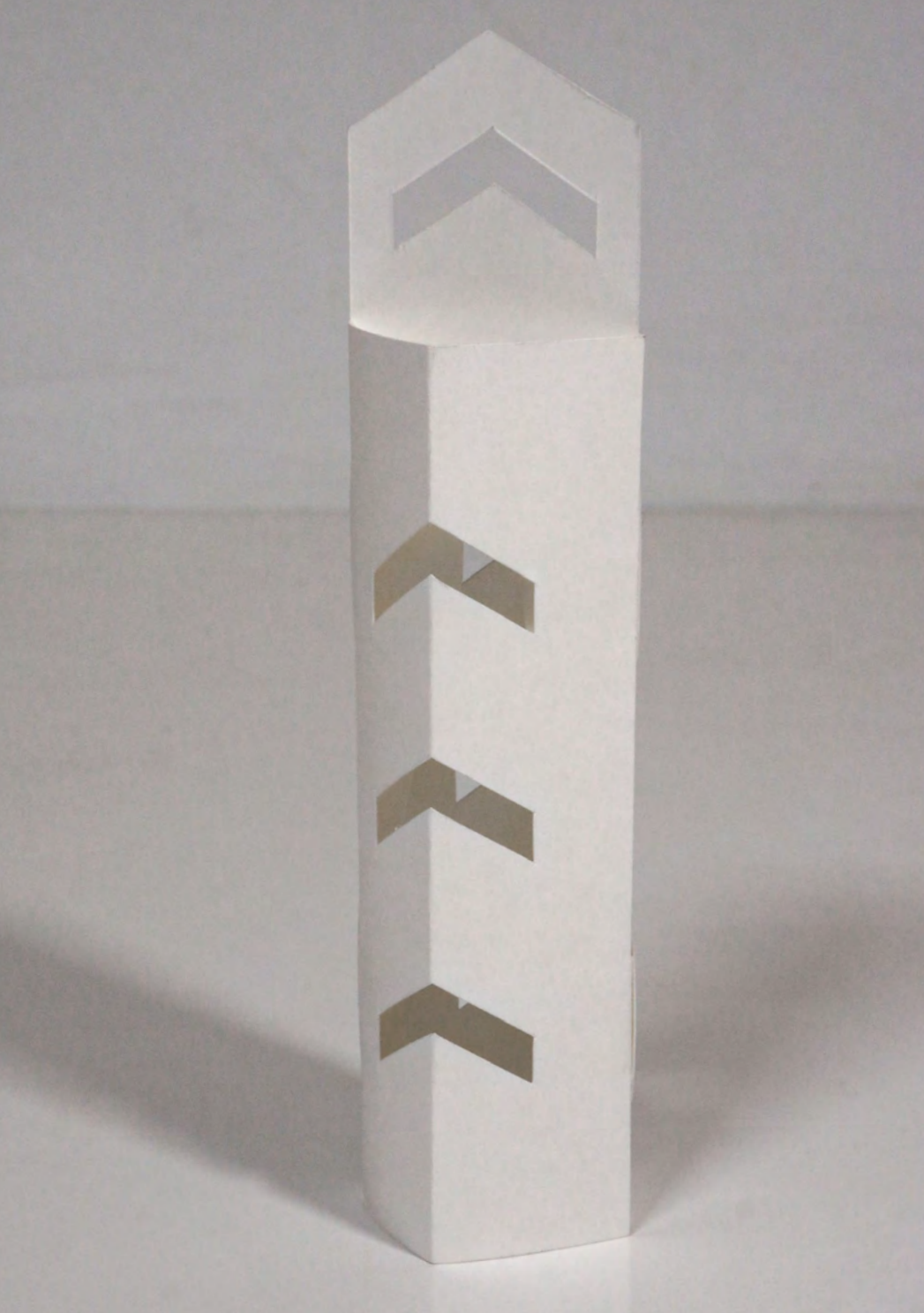

DISPLAY BOX

This display box is based on one of our childhood favorite packaging structures: crayons. The level of interactivity and displaying action makes this a winner for cosmetics, or anything requiring a little extra user interaction.

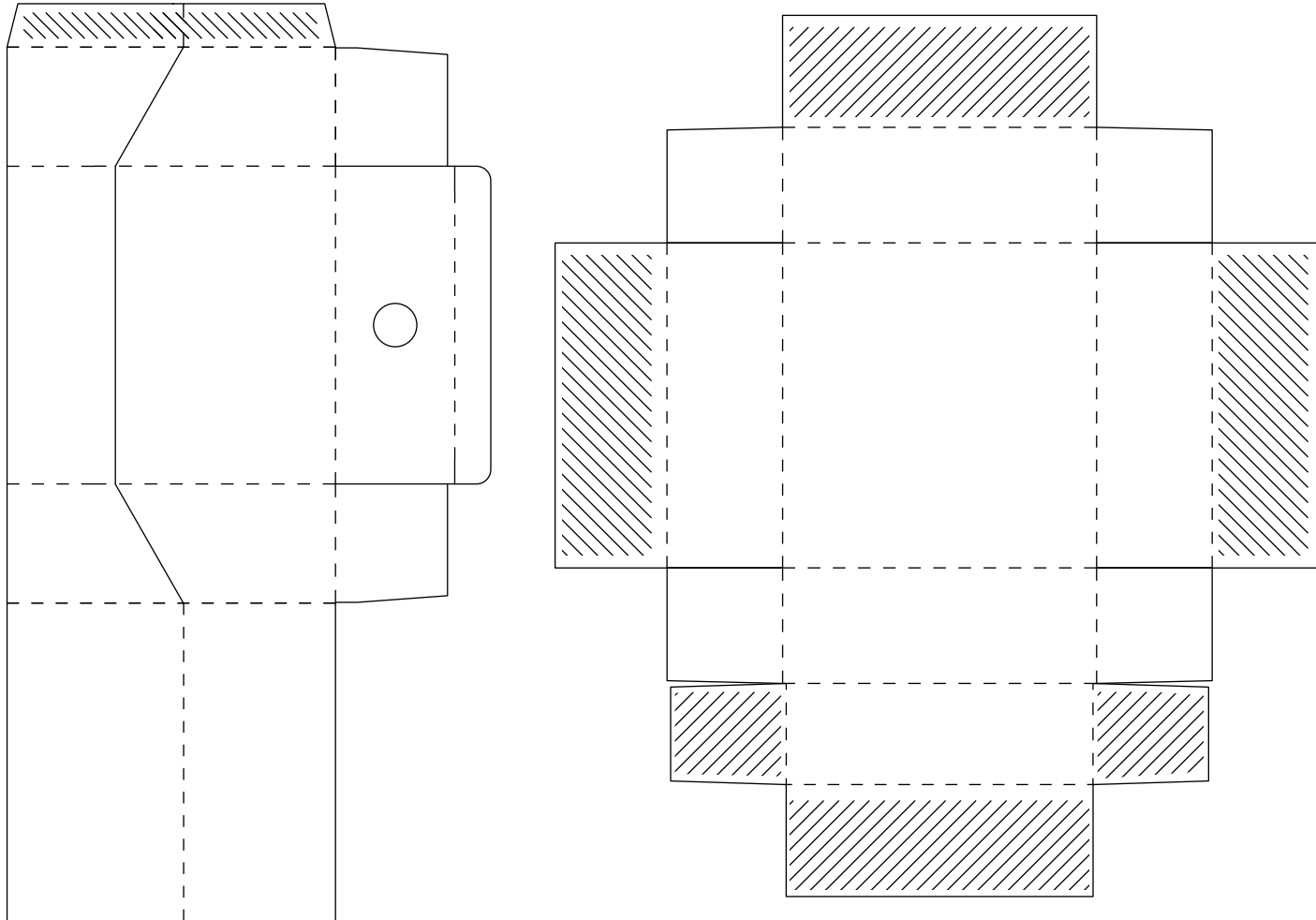

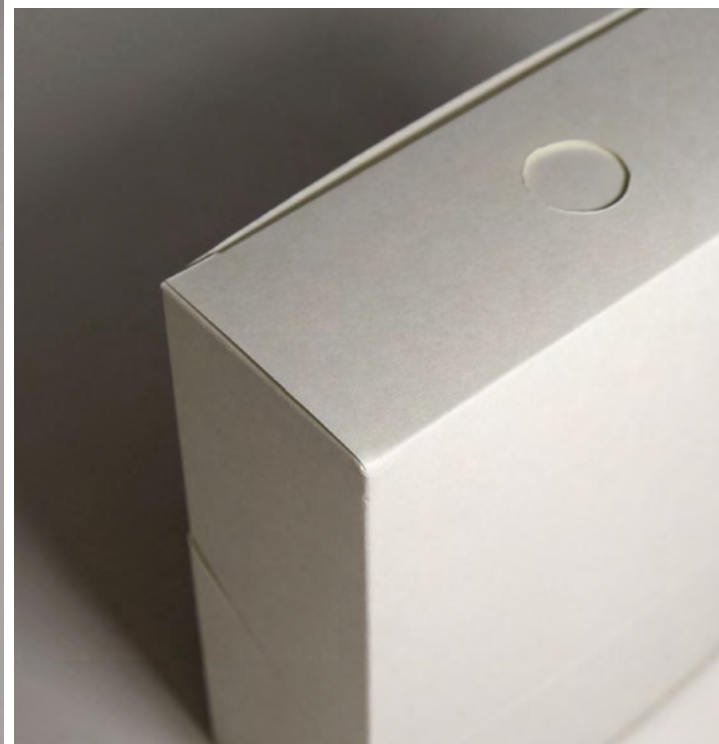
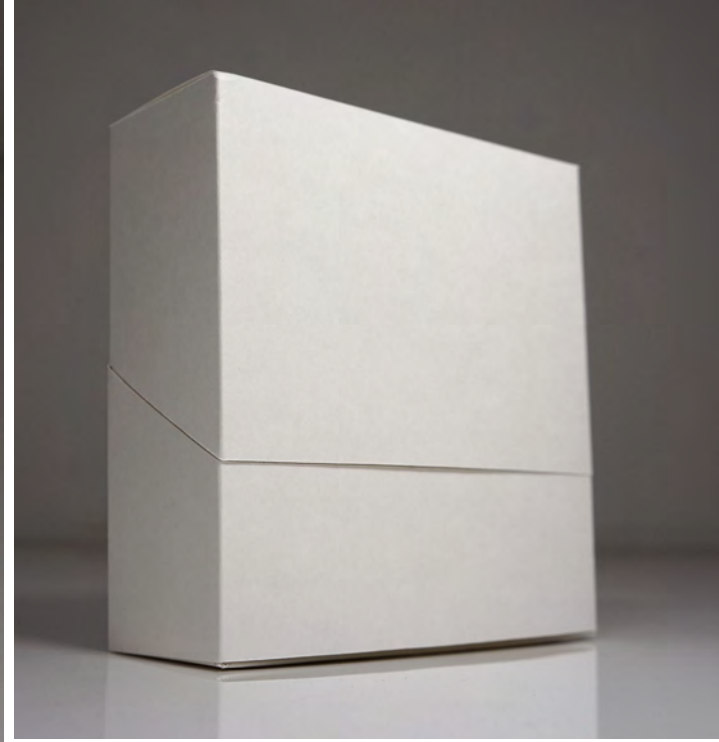

PIN-WHEEL TAKE OUT BOX

The Pin-Wheel Take Out Box is a variation on the traditional Chinese take out box, except with a twist (no pun intended). The flaps layer over each other and lock in place in a swirl motion, giving it a more playful look.

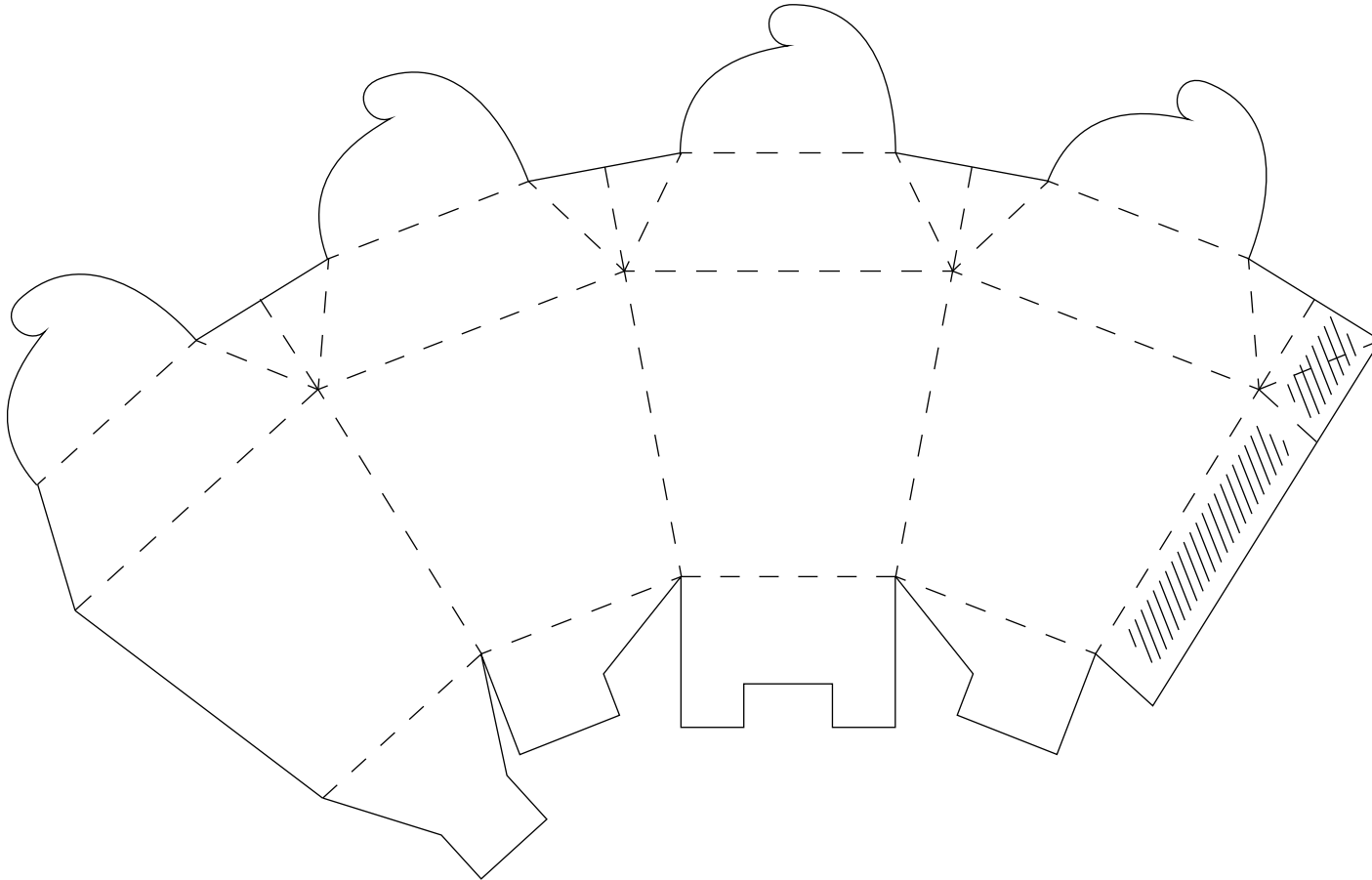

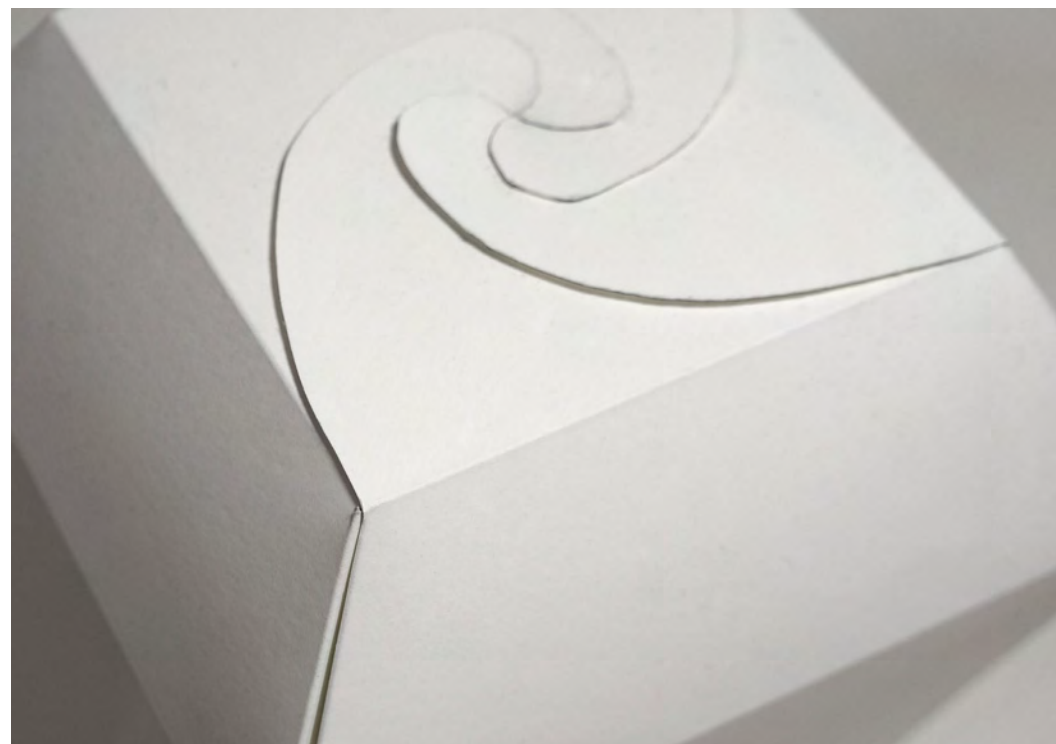

HANGING FACETED WINDOW BOX

We're fascinated with facets. This simple structure folds flat, and pops up into a sharp-looking geometric compartment. It's ready to hold and display socks, tech gear, or anything else needing a distinct tactile presentation.

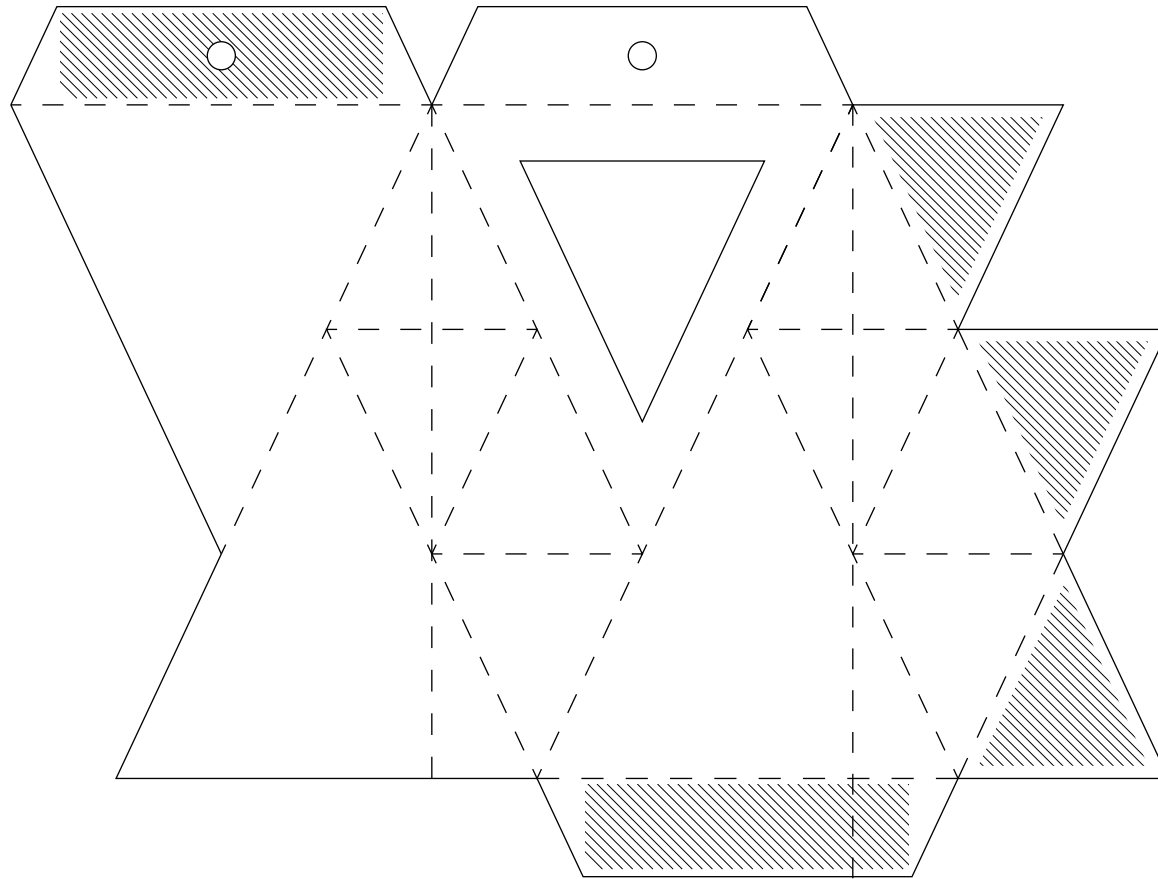

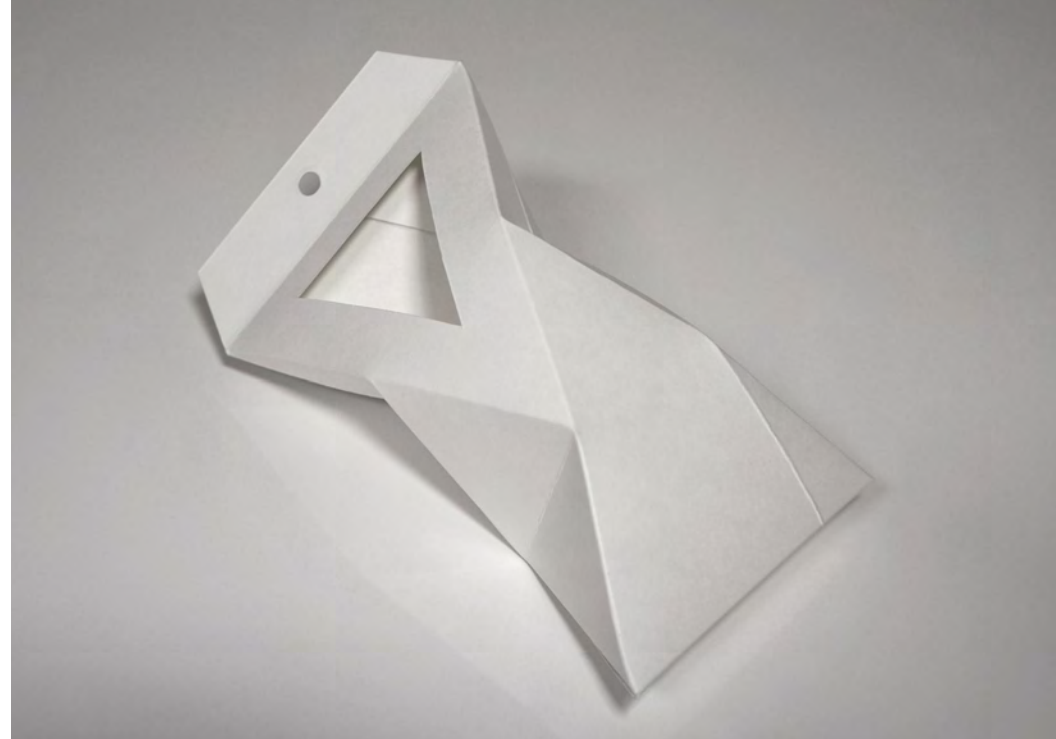

SLANTED TUCK BOX

The Slanted Top Box, is a perfect solution for products residing on the lower shelves at retail. The top presents product information at an angle, making it easy to locate the product for busy shoppers. The angled dust flaps fold in, securing the product.

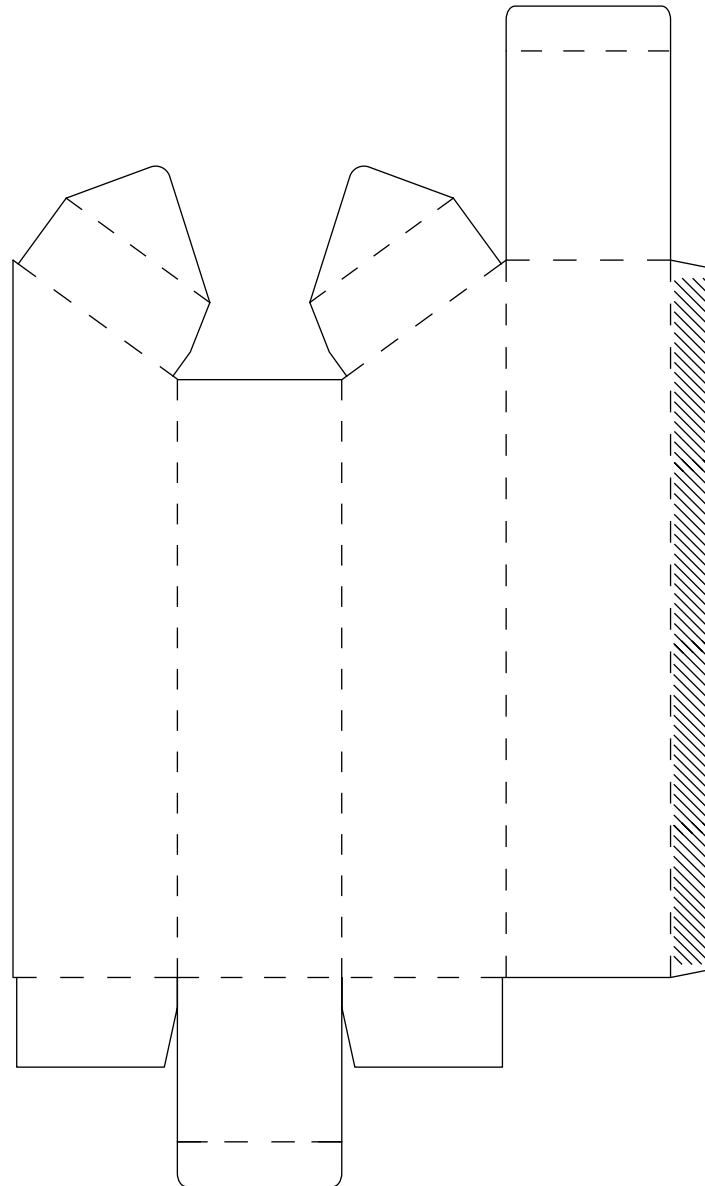

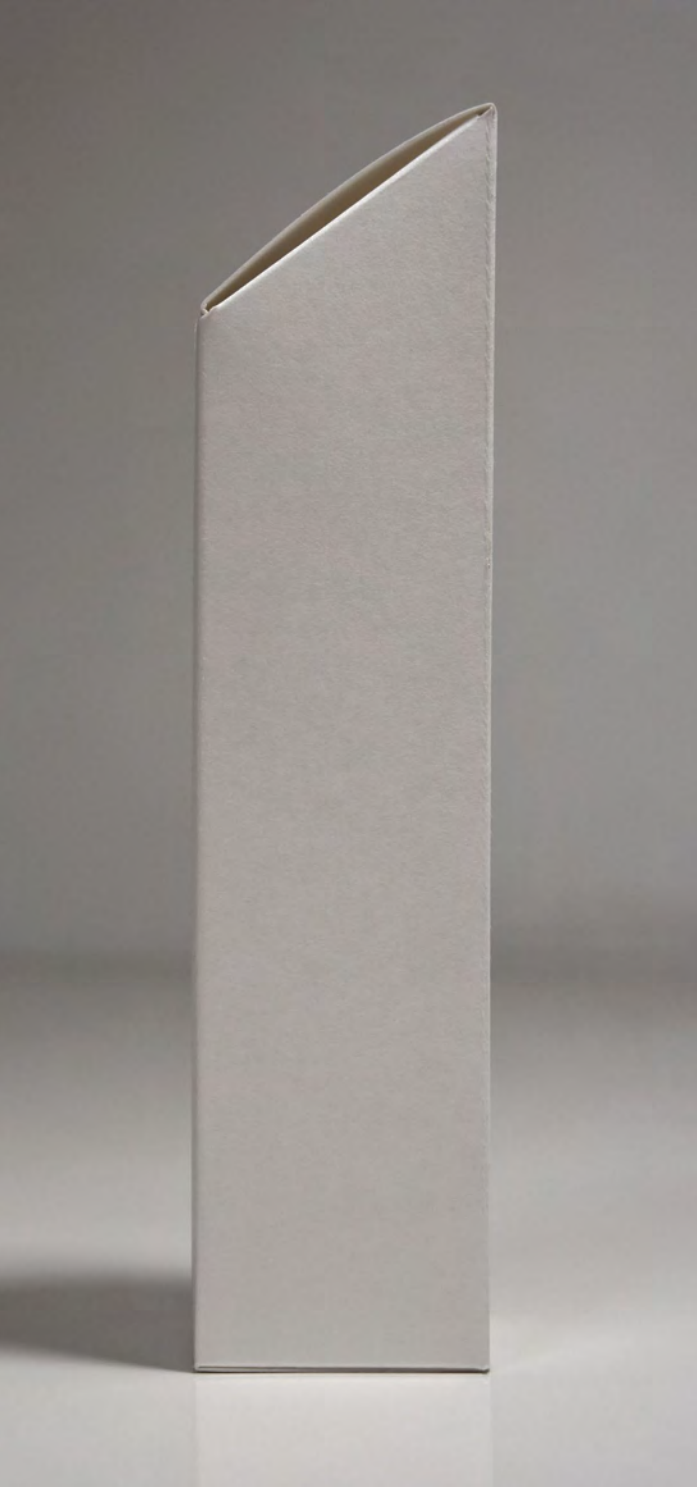



GIFT CARD CARRIERS

Gift card carriers provide the gift aesthetic to a relatively boring flat plastic card. The balance between scale, unveiling, and material waste walks a fine line. The unveiling process of a gift card carrier has to meet three criteria: create anticipation upon receiving, provide adequate space for personalized messaging, and delay direct access to the gift card through a simple unveiling process. Meet these three criteria to create a memorable sense of value and thoughtfulness in the act of gifting a plastic gift card. We recommend that you always print out the dielines to confirm dimensions, proportions, user experience, and that the structure is what you envisioned prior to applying artwork.

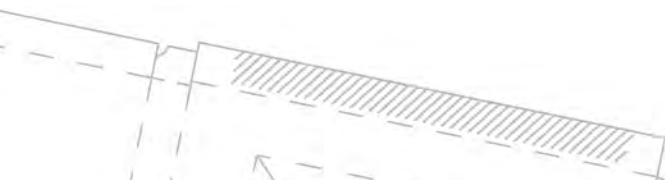

TRI-FOLD GIFT CARD CARRIER

The Tri-Fold Gift Card Carrier provides volume and creates adequate space on the fold-over flaps for branding as well as personalization. It instantly makes this carrier a keepsake long after the cards value has been monetarily depleted.

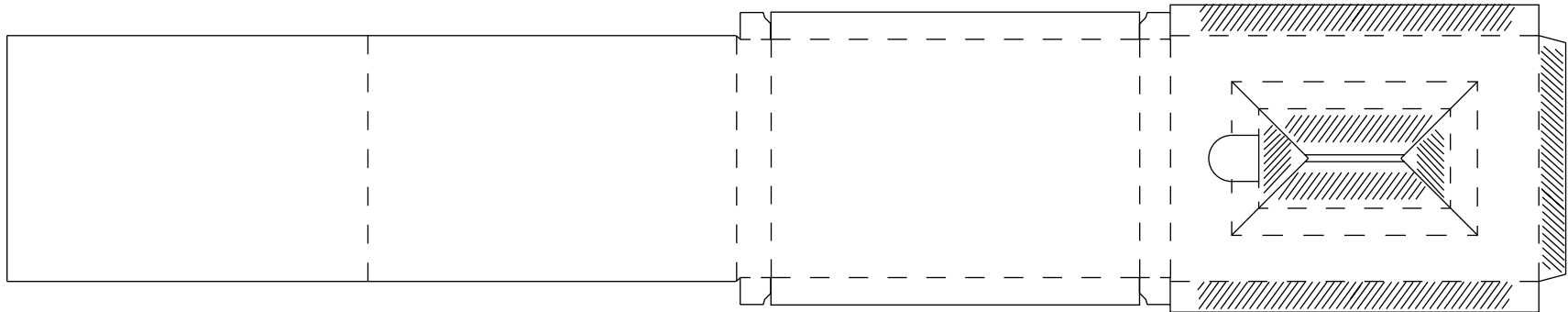

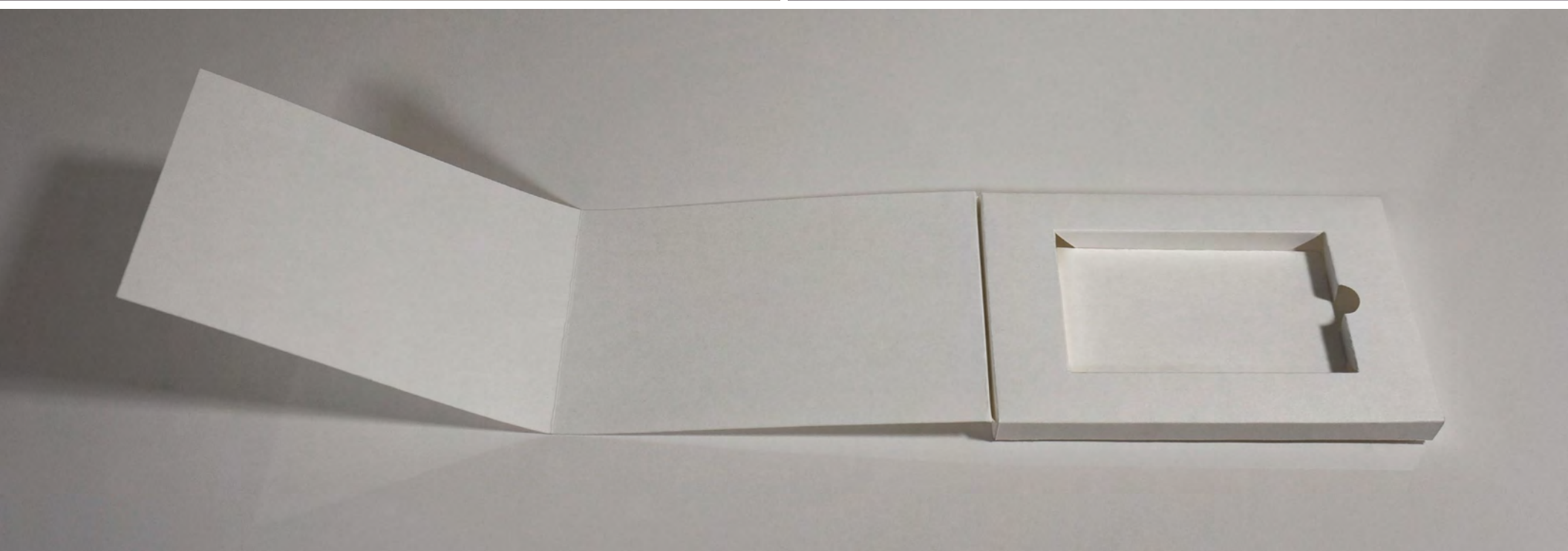
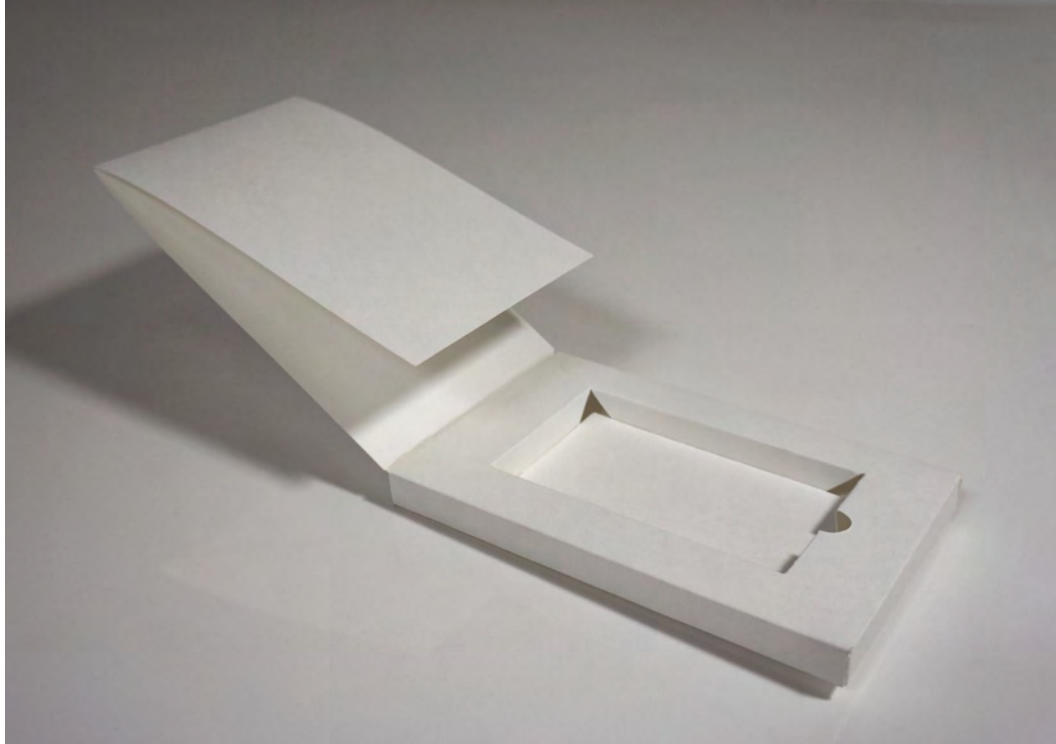
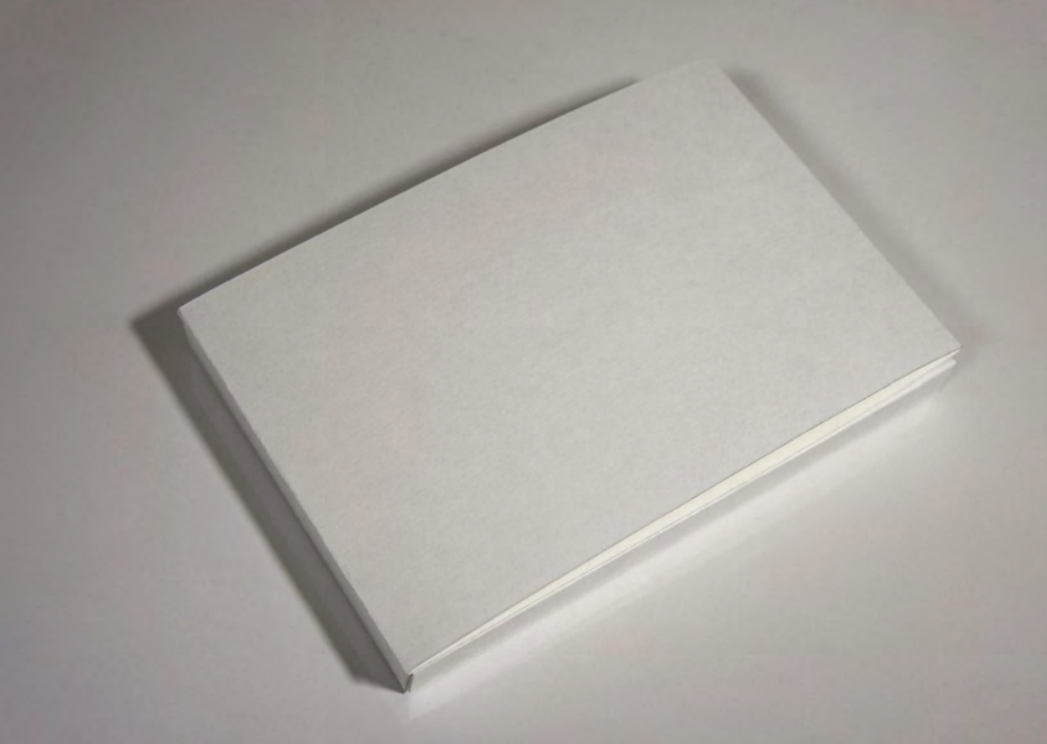

A-FRAME GIFT CARD CARRIER

Not all gift card carriers need to be flat. This A-frame carrier is perfect for merchandising at cashwrap with its large billboard areas, while the flat base allows it to stand up and be noticed.

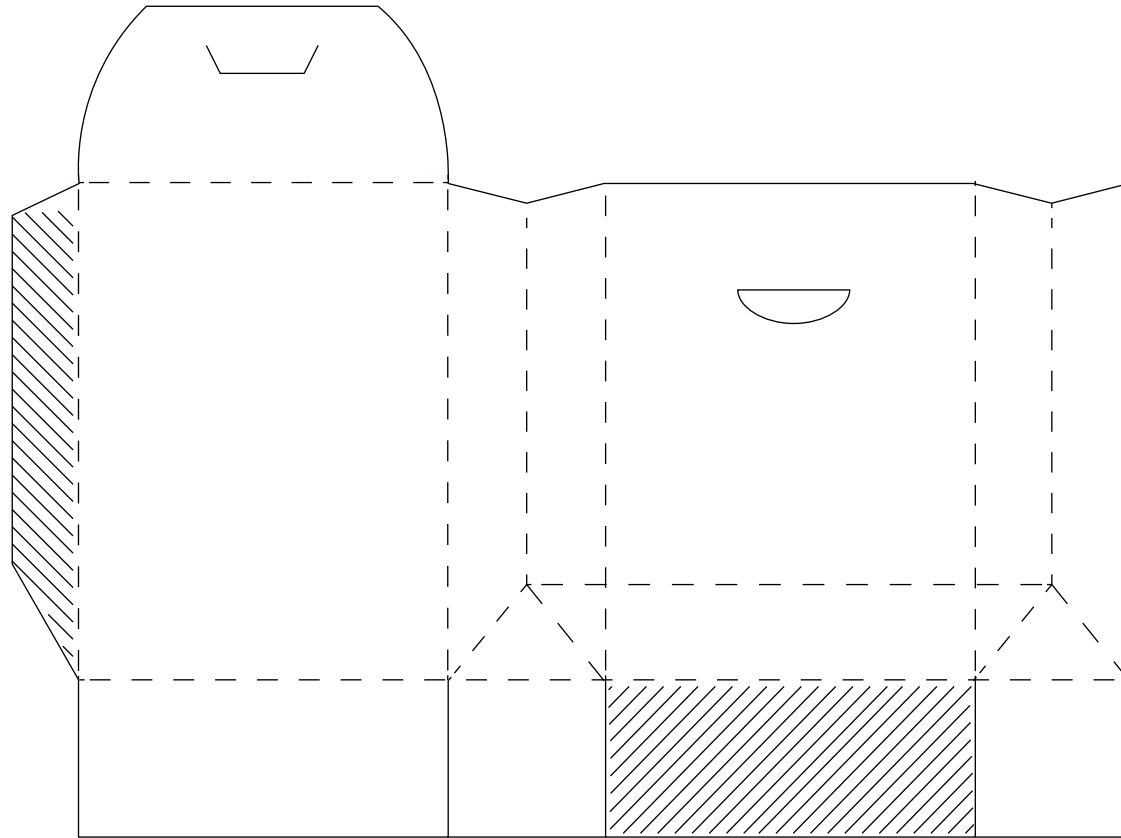

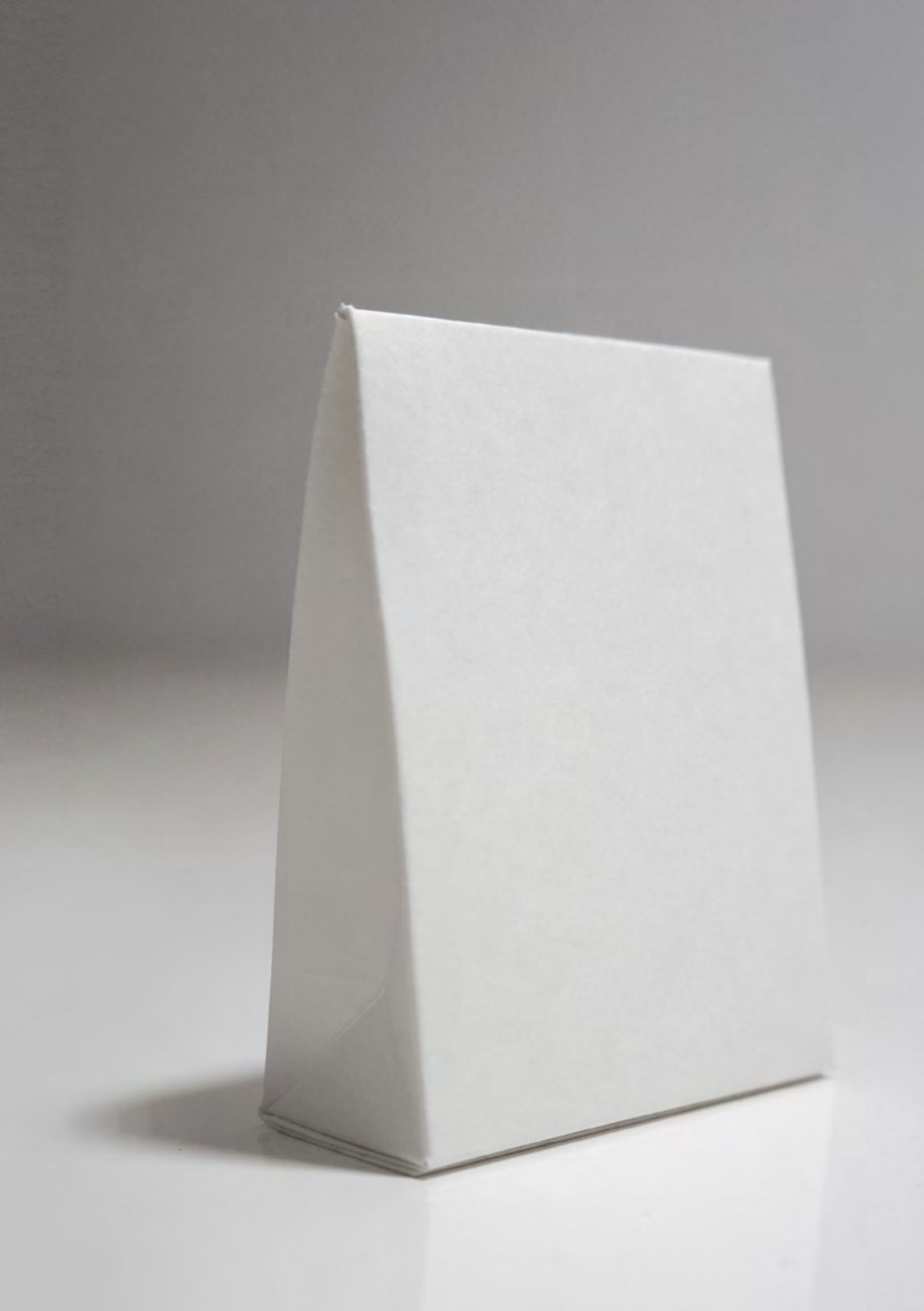

WAVE GIFT CARD CARRIER

No waves no glory. This surf-inspired gift card carrier opens to reveal a barrel wave that will get the user super stoked. The simple construction utilizes a row of slits on the wave strip that when glued, creates an experiential moment.

Click to See More

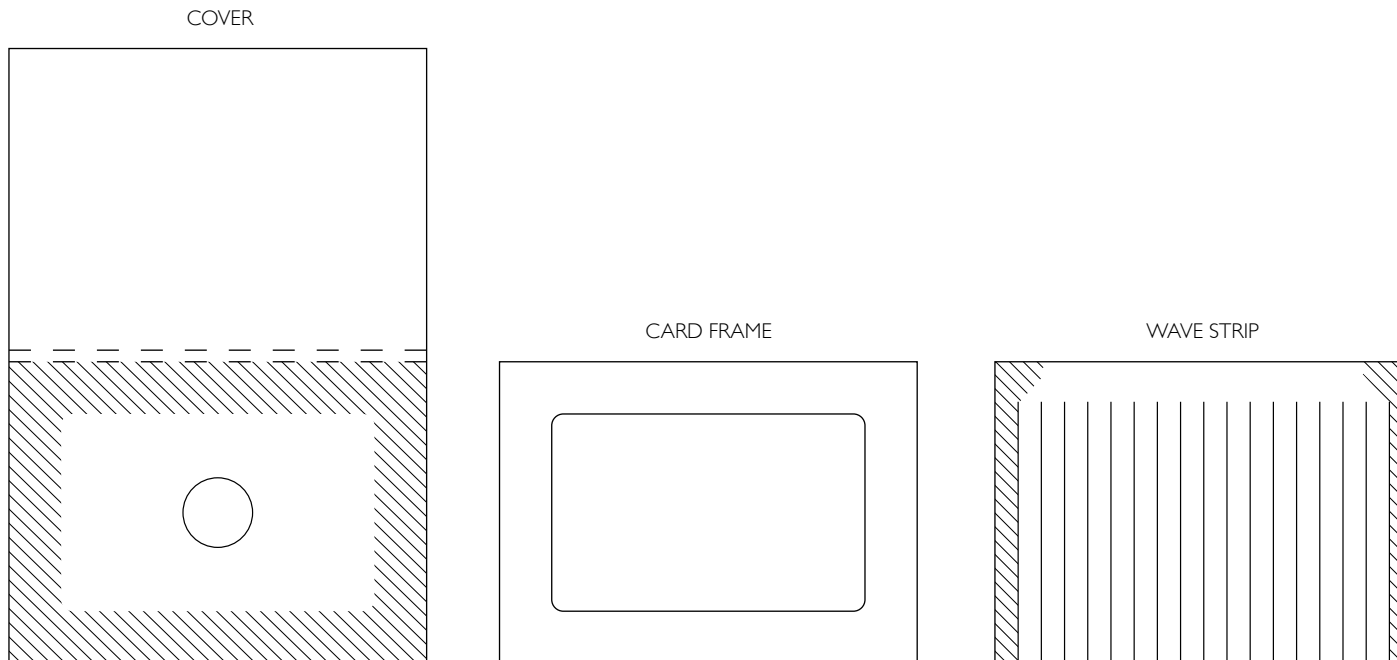

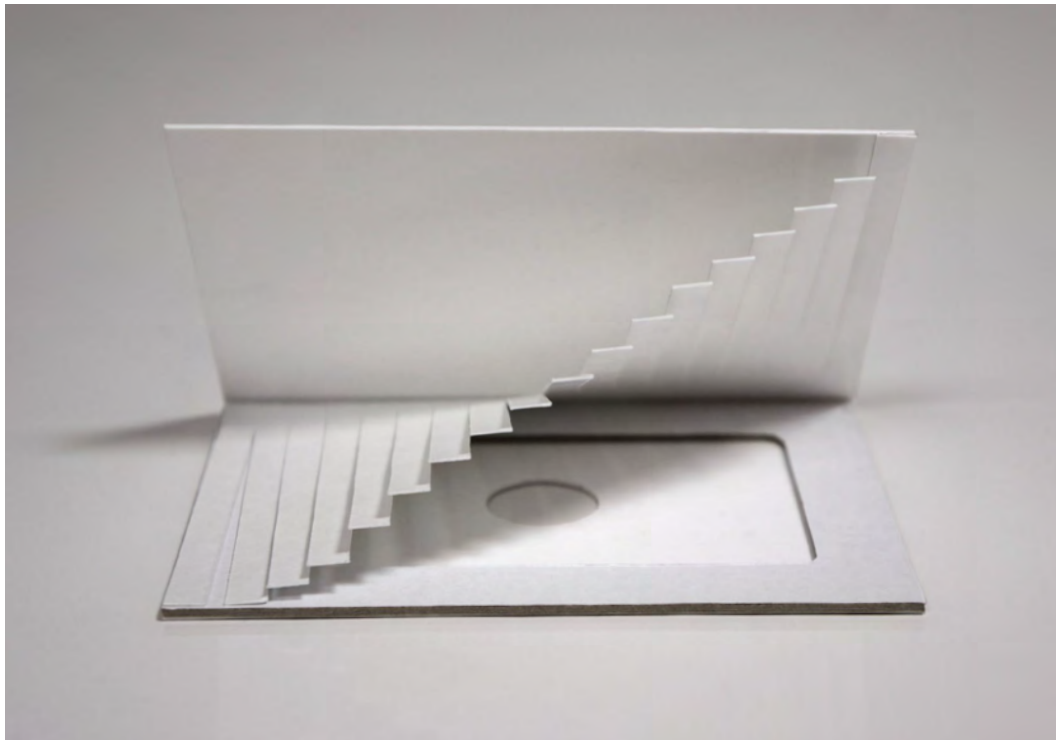
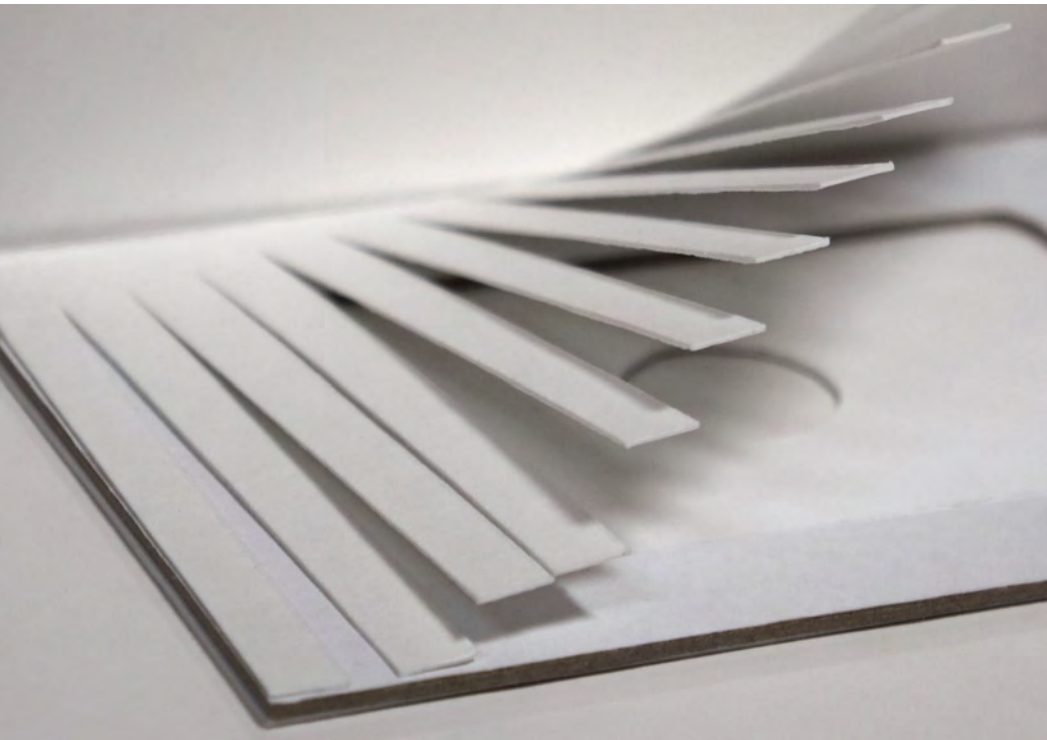
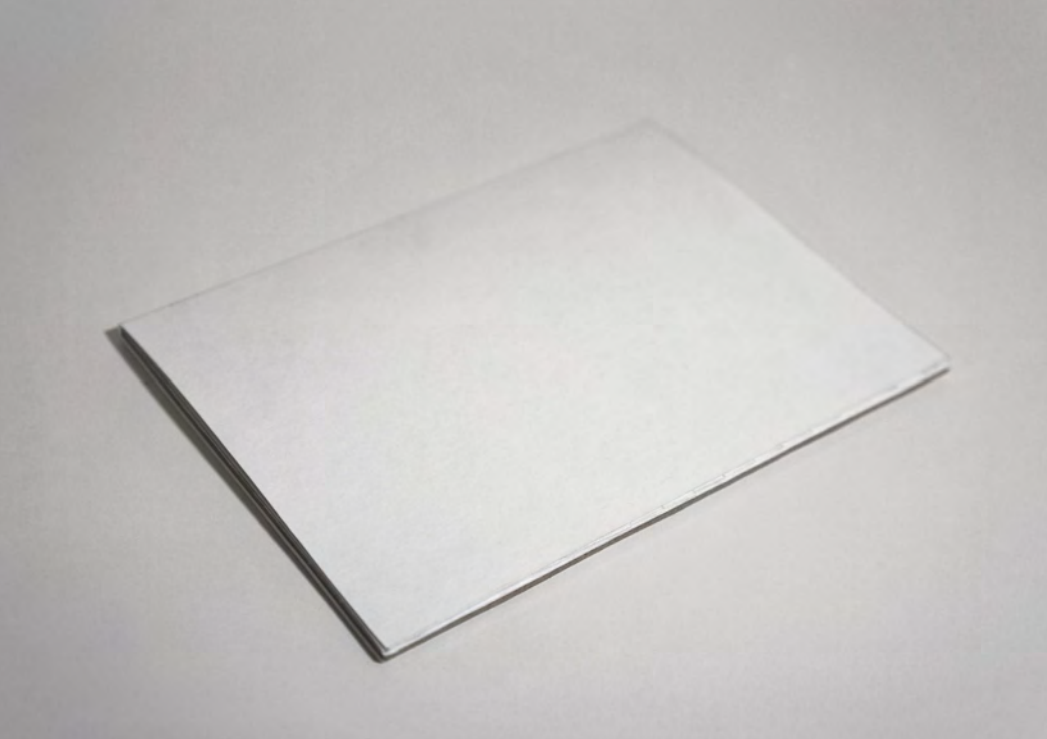

DOWNLOAD INSTRUCTIONS

1. Click on Share. 
2. Click on Download.
3. Open the PDF in Illustrator to desired page.

CREDITS

EVELIO MATTOS, Creative Director at Design Packaging | GEORGE BERNAL, Production Artist

ROB REPTA, Senior Packaging Designer | JOHNATHAN TURNER, Structural Packaging Designer

THANK YOU



Established in 2007, the Dieline remains the industry's source for package design, ushering a new wave of designers and enthusiasts.

PACKAGING & DIE LINES: THE DESIGNER'S BOOK OF DIE LINES

2014 Design Packaging, Inc.

Design Packaging Inc., 7880 East McClain Drive, Scottsdale, AZ 85260

Packaging & Dielines: The Designer's Book of Dielines is a free digital publication. By downloading, sharing, or embedding any portion of this publication, you agree that no part of this publication may be reproduced, distributed, or transmitted in any form or any means, including photocopying, recording, or other electronic or mechanical methods for a fee or profit. All contents in this publication must remain free of charge, with no copyright or attribution.

Page 113

Packaging & Dielines | designpackaginginc.com

LET'S CONNECT.



designpackaging